

Speciated and total emission factors of particulate organics from burning western U.S. wildland fuels and their dependence on combustion efficiency

Coty N. Jen^{1,6}, Lindsay E. Hatch², Vanessa Selimovic³, Robert J. Yokelson³, Robert Weber¹, Arantza E. Fernandez⁴, Nathan M. Kreisberg⁴, Kelley C. Barsanti², Allen H. Goldstein^{1,5}

¹ Department of Environmental Science, Policy, and Management, University of California, Berkeley, Berkeley, CA, 94720 USA

² Department of Chemical and Environmental Engineering and College of Engineering – Center for Environmental Research and Technology, University of California, Riverside, Riverside, CA, 92507, USA

³ Department of Chemistry, University of Montana, Missoula, 59812, USA

⁴ Aerosol Dynamics Inc., Berkeley, CA 94710, USA

⁵ Department of Civil and Environmental Engineering, University of California, Berkeley, Berkeley, CA 94720, USA

⁶ now at Department of Chemical Engineering, Carnegie Mellon University, Pittsburgh, PA 15213, USA

Supporting Information:

- 1. Sampling position and diagram of DEFCON, Direct Emission Fire CONcentrator**
- 2. I/SVOCs from the FIREX FSL experiments-- University of California, Berkeley-Goldstein Library of Biogenic and Environmental Spectra (UCB-GLOBES)**
- 3. Conversion of instrument response to mass loadings and emission factors**
- 4. Internal/external standards and mass loading calibration curves**
- 5. Classifying unidentified compounds into chemical families**
- 6. Classified I/SVOC mass fractions averaged over fuel type**
- 7. EFs for families of compounds as a function of MCE**

1. Sampling position and diagram of DEFCON, Direct Emission Fire CONcentrator:

Smoke was collected directly from the stack at a position ~17 m above the burn (Figure S1). A flow of 10.3 LPM was pulled through DEFCON. 300 sccm of the flow was diverted to two parallel absorbent tube sampling channels (150 sccm each channel). The remainder of the smoke flow (10 LPM) was then passed through a 1.0 μm cyclone prior to collection on a 10 cm quartz fiber filter. Flow rates were continuously monitored to ensure correct flows. All metal surfaces except for the cyclone and filter holders were passivated with Inertium® to minimize loss of oxygenated organics (Williams et al., 2006). A diagram of DEFCON is given in Figure S2.

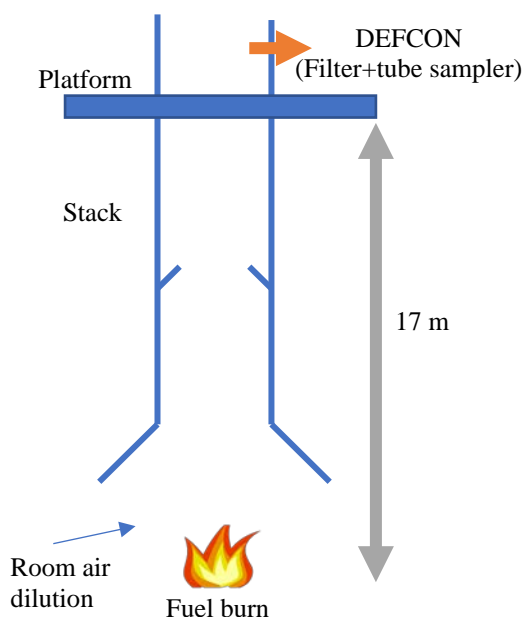

Figure S1 Diagram of the smoke stack in the burn room and the placement of DEFCON

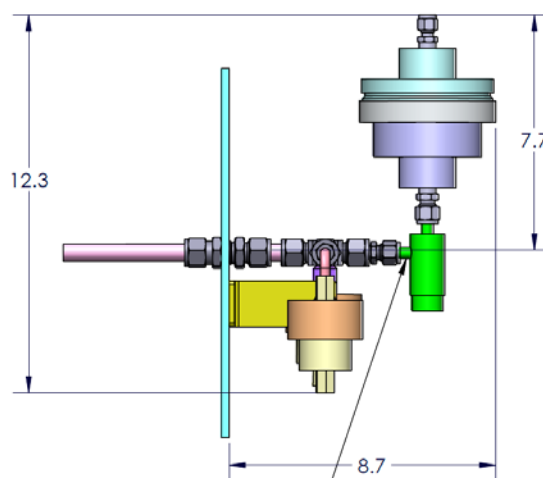

Figure S2 Schematic of DEFCON and how it sampled from the stack

2. I/SVOCs from the FIREX FSL experiments-- University of California, Berkeley- Goldstein Library of Organic Biogenic and Environmental Spectra (UCB-GLOBES):

The mass spectrum and retention index of each compound separated by the TD-GC \times GC-EI/VUV-HRToFMS was compared to the NIST mass spectral database (2014 version) and/or to previous literature. Table S1 provides a list of all 149 identified compounds and its identification method. In addition, all separated and unique compounds from the 29 analyzed burns were compiled into UCB-GLOBES (FIREX), <https://nature.berkeley.edu/ahg/data/MSLibrary/>. Information includes compound chemical classification, deuterated and non-deuterated *n*-alkane retention indices, mass spectrum, instrument/method details, derivatization agent, list of fuel, and, if found in 10 or more burns, the slope, intercept, standard errors, and R^2 for the model $\log(\text{EF})=\text{slope}(\text{MCE})+\text{int}$. UCB-GLOBES (FIREX) is NIST MS Search compatible and can be used in the future to better identify biomass-burning derived organic compounds found in the atmosphere.

Table S1 List of identified compounds and their sources, characteristic EI ions and retention index (RI). Compounds were identified using a combination of RI, mass spectrum, VUV parent ion mass, or standard matching.

| Compound name | Underiv. Formula | Derivatized Formula | Exact Mass (no deriv) | Exact Mass (Deriv) | Top 5 masses (deriv) | RI | ID Method | Comments |
|---------------------------------|------------------|---------------------|-----------------------|--------------------|-------------------------|------|------------------|------------------------------------------------|
| Glycerol 3TMS | C3H8O3 | C12H32O3Si3 | 92.047 | 308.166 | 69, 73, 147, 131, 205 | 1266 | RI, MS, VUV | All forms of pine, dung, rice straw, sage |
| Glyceric acid 3TMS | C3H6O4 | C12H30O4Si3 | 106.027 | 322.145 | 73, 147, 189, 133, 117 | 1319 | RT, MS, VUV | Rotten log |
| Catechol 2TMS | C6H6O2 | C12H22O2Si2 | 110.037 | 254.116 | 73, 254, 239, 45, 74 | 1307 | RT, MS, VUV, STD | All |
| Hydroquinone 2 TMS | C6H6O2 | C12H22O2Si2 | 110.037 | 254.116 | 239, 254, 73, 240, 255 | 1393 | RT, MS, VUV, STD | All |
| Resorcinol 2TMS | C6H6O2 | C12H22O2Si2 | 110.037 | 254.116 | 239, 254, 73, 69, 91 | 1372 | RT, MS, VUV, STD | All forms of pine, ground, manzanita, juniper |
| 1,2-cyclohexanediol | C6H12O2 | C12H28O2Si2 | 116.084 | 260.162 | '147, 73, 142, 81, 245' | 1253 | RT, MS, VUV | Duff |
| Butanedioic acid 2TMS | C4H6O4 | C10H22O4Si2 | 118.027 | 262.106 | 147, 73, 75, 148, 45 | 1306 | RI, MS, VUV | All |
| 3-methylcatechol 2TMS | C7H8O2 | C13H24O2Si2 | 124.052 | 268.131 | 73, 268, 74, 45, 253 | 1379 | RI, MS, VUV | All |
| 4-methylcatechol 2TMS | C7H8O2 | C13H24O2Si2 | 124.052 | 268.131 | 73, 69, 268, 253, 45 | 1390 | RT, MS, VUV, STD | All |
| Benzoic acid TMS stereoisomer 1 | C7H8O2 | C10H16O2Si | 124.052 | 196.092 | 105, 179, 135, 77, 194 | 1242 | RI, MS, VUV | All |
| Benzoic Acid TMS stereoisomer 2 | C7H8O2 | C10H16O2Si | 124.052 | 196.092 | 105, 179, 135, 77, 194 | 1234 | RI, MS, VUV | All |
| Methylhydroquinone 2TMS | C7H8O2 | C13H24O2Si2 | 124.052 | 268.131 | 268, 253, 73, 237, 254 | 1454 | RI, MS, VUV | All |
| 5-(hydroxymethyl) furfural TMS | C6H6O3 | C9H14O3Si | 126.032 | 198.071 | 183, 109, 111, 73, 81 | 1304 | RI, MS, VUV | All |
| Maltol TMS | C6H6O3 | C9H14O3Si | 126.032 | 198.071 | 183, 184, 153, 75, 111 | 1277 | RT, MS, VUV, STD | All |
| Pyrogallol 3TMS | C6H6O3 | C15H30O3Si3 | 126.032 | 342.150 | 239, 73, 342, 240, 211 | 1531 | RT, MS, VUV | All |
| Pyroglutamic acid TMS | C5H7NO3 | C11H23NO3Si2 | 129.043 | 273.122 | 84, 75, 73, 41, 45 | 1492 | RT, MS, VUV, STD | All |
| Methylsuccinic acid 2TMS | C5H8O4 | C11H24O4Si2 | 132.042 | 276.121 | 73, 147, 217 | 1317 | RT, MS, VUV | All forms of pine, bear grass, dung, manzanita |

| | | | | | | | | |
|----------------------------------------------------|---------|--------------|---------|---------|------------------------|------|------------------|------------------------------------------------------------|
| 3-hydroxyacetophenone TMS | C8H8O2 | C11H16O2Si | 136.052 | 208.092 | 193, 73, 208, 43, 75 | 1466 | RI, MS, VUV | All |
| 3-Hydroxybenzoic acid 2 TMS | C7H6O3 | C13H22O3Si2 | 138.032 | 282.111 | 267, 223, 193, 73, 282 | 1558 | RI, MS, VUV | All |
| 4-Hydroxybenzoic acid 2TMS | C7H6O3 | C13H22O3Si2 | 138.032 | 282.111 | 267, 223, 73, 193, 268 | 1622 | RI, MS, VUV | All |
| 1-4:3-6-Dianhydro-alpha-d-glucopyranose TMS | C6H8O4 | C9H16O4Si | 144.042 | 216.081 | 73, 129, 75, 155, 170 | 1338 | RI, MS, VUV | All |
| Arabinonic acid, 1,4-lactone 3TMS | C5H8O5 | C14H32O5Si3 | 148.037 | 364.156 | 73, 147, 117, 75, 217 | 1627 | RI, MS, VUV | All pine forms, bear grass, manzanita |
| P-Coumaric alcohol 2TMS | C9H10O2 | C15H26O2Si2 | 150.068 | 294.147 | 73, 205, 294 | 1625 | RI, MS, VUV | All forms of pine and juniper |
| 2, 4-dihydroxyacetophenone 2TMS | C8H8O3 | C14H24O3Si2 | 152.047 | 296.126 | 217, 73, 281, 218, 75 | 1688 | RI, MS, VUV | All forms of pine |
| Vanillin TMS | C8H8O3 | C11H16O3Si | 152.047 | 224.087 | 194, 193, 209, 73, 195 | 1529 | RT, MS, VUV, STD | All forms of pine, peat, juniper |
| Arabinitol 5TMS | C5H12O5 | C20H52O5Si5 | 152.068 | 512.266 | 73, 217, 147, 103, 205 | 1713 | RI, MS | All pine forms except rotten log |
| Protocatechoic acid 3TMS | C7H6O4 | C16H30O4Si3 | 154.027 | 370.145 | 193, 73, 370, 355, 311 | 1812 | RT, MS, VUV | All forms of pine, peat, sage, juniper |
| Syringol TMS | C8H10O3 | C11H18O3Si | 154.063 | 226.103 | 196, 211, 181, 69, 197 | 1391 | RT, MS, VUV, STD | All |
| 4-nitrocatechol 2TMS | C6H5NO4 | C12H21NO4Si2 | 155.022 | 299.101 | 73, 284, 299, 45, 74 | 1738 | RI, MS, VUV, STD | All |
| Nonanoic acid TMS | C9H18O2 | C12H26O2Si | 158.131 | 230.170 | 69, 75, 131, 73, 117 | 1353 | RT, MS, VUV, STD | All |
| 1-8-dihydroxynaphthalene 2TMS | C10H8O2 | C16H24O2Si2 | 160.052 | 304.131 | 73, 304, 217, 45, 74 | 1815 | RI, MS, VUV | All |
| Umbelliferone TMS | C9H6O3 | C12H14O3Si | 162.032 | 234.071 | 219, 234, 73, 220, 191 | 1818 | RT, MS, VUV | All forms of pine, dung, manzanita, grasses, sage, juniper |
| Deoxy-ribo-hexonic acid 1-4-lactone 3 TMS | C6H10O5 | C15H34O5Si3 | 162.053 | 378.171 | 73, 147, 129, 155, 103 | 1764 | RI, MS | All |
| Galactosan 3TMS | C6H10O5 | C15H34O5Si3 | 162.053 | 378.171 | 217, 73, 204, 218, 147 | 1654 | RT, MS, VUV, STD | All |

| | | | | | | | | |
|--------------------------------------------|----------|------------------|---------|---------|----------------------------|------|---------------------|----------------------------------------------|
| Levoglucozan 3 TMS | C6H10O5 | C15H34O5Si3 | 162.053 | 378.171 | 73, 204, 217, 147, 189 | 1698 | RT, MS, VUV, STD | All |
| Mannosan 3TMS | C6H10O5 | C15H34O5Si3 | 162.053 | 378.171 | 73, 217, 204, 191, 147 | 1676 | RI, MS | All forms of pine |
| 4-Coumaric acid 2TMS | C9H8O3 | C15H24O3Si2 | 164.047 | 308.126 | 293, 219, 73, 249, 308 | 1934 | RI, MS, VUV | All |
| Eugenol TMS | C10H12O2 | C13H20O2Si | 164.084 | 236.123 | 206, 221, 236, 179, 73 | 1464 | RT, MS, VUV | Engelmann spruce duff |
| 4-vinylveratrole | C10H12O2 | | 164.084 | | 164, 149, 91, 77, 121 | 1358 | RT, MS, VUV | Duff |
| Isoeugenol TMS | C10H12O2 | C13H20O2Si | 164.084 | 236.123 | 206, 205, 236, 207, 69 | 1562 | RI, MS, VUV | All forms of pine, dung, grasses, juniper |
| Acetovanillone TMS | C9H10O3 | C12H18O3Si | 166.063 | 238.103 | 193, 223, 208, 73, 238 | 1612 | RI, MS, VUV | All |
| Phloretic acid 2TMS | C9H10O3 | C15H26O3Si2 | 166.063 | 310.142 | 179, 73, 180, 75, 45 | 1806 | RT, MS, VUV | Bear grass, pine, manzanita |
| 3-(Methylthio)benzoic acid TMS | C8H8O2S | C11H16O2SSi | 168.025 | 240.064 | 225, 181, 151, 240, 75 | 1640 | RI, MS, VUV | Rotten log |
| Methyl 3,4-dihydroxybenzoate 2TMS | C8H8O4 | C14H24O4Si2 | 168.042 | 312.121 | 193, 73, 312, 194, 45 | 1714 | RI, MS, VUV | All forms of pine |
| Vanillic acid 2TMS | C8H8O4 | C14H24O4Si2 | 168.042 | 312.121 | 297, 267, 223, 253, 282 | 1755 | RT, MS, VUV, STD | All |
| 1-acenaphthenone | C12H8O | | 168.058 | | 140, 168, 139, 73, 89 | 1665 | RI, MS, VUV | Pine, sage, juniper |
| Homovanillyl alcohol 2TMS | C9H12O3 | C15H28O3Si2 | 168.079 | 312.158 | 209, 73, 312, 210, 179 | 1702 | RT, MS, VUV | All |
| Methylsyringol TMS | C9H12O3 | C12H20O3Si | 168.079 | 240.118 | 210, 69, 211, 225, 240 | 1476 | RT, MS, VUV | All |
| Methyl nitrocatechol 2 TMS isomer 1 | C7H7NO4 | C10H15NO4Si i | 169.038 | 241.077 | 73, 296, 45, 313, 180 | 1771 | RI, MS, VUV | All |
| Methyl nitrocatechol 2 TMS isomer 2 | C7H7NO4 | C10H15NO4Si i | 169.038 | 241.077 | 73, 298, 75, 45, 74 | 1828 | RI, MS, VUV | All |
| Gallic acid 4TMS | C7H6O5 | C19H38O5Si4 | 170.022 | 458.180 | 281, 73, 443, 458, 179 | 1947 | RI, MS, VUV | Manzanita |

| | | | | | | | | |
|------------------------------------------------|----------|-------------|---------|---------|-------------------------|------|------------------|-------------------------------------------|
| 1,4-Dihydroxy-2,6-dimethoxybenzene 2TMS | C8H10O4 | C14H26O4Si2 | 170.058 | 314.137 | 284, 314, 73, 299, 269 | 1669 | RI, MS, VUV | All |
| 4-phenylphenol TMS | C12H10O | C15H18OSi | 170.073 | 242.113 | 211, 227, 73, 242, 310 | 1771 | RI, MS, VUV | All |
| Shikimic acid 4TMS | C7H10O5 | C19H42O5Si4 | 174.053 | 462.211 | 204, 73, 147, 205, 206 | 1803 | RT, MS, VUV | Pine and pine litter |
| Esculetin 2 TMS | C9H6O4 | C15H22O4Si2 | 178.027 | 322.106 | 73, 322, 307, 45 | 2093 | RT, MS, VUV | Sage |
| Coniferyl aldehyde TMS | C10H10O3 | C13H18O3Si | 178.063 | 250.103 | 220, 219, 250, 192, 73 | 1839 | RT, MS, VUV | All |
| Phenanthrene | C14H10 | | 178.078 | | 178, 73, 176, 152, 177 | 1791 | RT, MS, VUV, STD | All |
| 9-fluorenone | C13H8O | | 180.058 | | 180, 152, 151, 181, 150 | 1745 | RI, MS, VUV | All |
| Benzocinnoline | C12H8N2 | | 180.069 | | 152, 180, 151, 76, 150 | 1913 | RI, MS, VUV | All |
| Coniferyl alcohol 2TMS | C10H12O3 | C16H28O3Si2 | 180.079 | 324.158 | 219, 193, 73, 309, 220 | 1946 | RI, MS, VUV | Pine and juniper |
| Homovanillic acid 2TMS | C9H10O4 | C15H26O4Si2 | 182.058 | 326.137 | 73, 209, 179, 267, 326 | 1761 | RI, MS, VUV | All |
| Syringaldehyde TMS | C9H10O4 | C12H18O4Si | 182.058 | 254.097 | 73, 204, 217, 224, 147 | 1695 | RT, MS, VUV, STD | Pine and manzanita |
| Dihydroconiferyl alcohol 2TMS | C10H14O3 | C16H30O3Si2 | 182.094 | 326.173 | 206, 205, 236, 73, 326 | 1811 | RI, MS, VUV | All |
| 6H-Cyclobuta[jk]phenanthrene | C15H10 | | 190.078 | | 190, 189, 95, 191, 187 | 1928 | RI, MS, VUV | Pine, shrubs, bear grass |
| Scopoletin TMS | C10H8O4 | C13H16O4Si | 192.042 | 264.082 | 234, 206, 264, 73, 249 | 2031 | RT, MS, VUV | Sage, rotten log, duff |
| Quinic acid 5TMS | C7H12O6 | C22H52O6Si5 | 192.063 | 552.261 | 73, 345, 255, 147, 69 | 1851 | RT, MS, VUV | Pine, manzanita, sage |
| 9-methylanthracene | C15H12 | | 192.094 | | 192, 191, 189, 190, 165 | 1936 | RI, MS, VUV | All |
| Methylanthracene isomer | C15H12 | | 192.094 | | 192, 191, 189, 190, 193 | 1906 | RI, MS, VUV | All forms of pine, dung, bear grass, sage |
| 1-methylanthracene | C15H12 | | 192.094 | | 192, 191, 189, 190, 193 | 1912 | RI, MS, VUV | All |

| | | | | | | | | |
|------------------------------------------------------------------|---------------|-----------------|---------|---------|-------------------------|------|------------------|--------------------------------------------------|
| Methyl caffeate 2TMS | C10H10O4 | C16H26O4Si2 | 194.058 | 338.137 | 73, 323, 249, 308, 338 | 2087 | RI, MS, VUV | All forms of pine, ground, grasses, juniper |
| Pinitol 5TMS | C7H14O6 | C22H54O6Si5 | 194.079 | 554.277 | 73, 217, 247, 147, 159 | 1788 | RT, MS, VUV, STD | Pine and pine litter |
| Naphthalic anhydride | C12H6O3 | | 198.032 | | 154, 126, 198, 63, 50 | 2038 | RI, MS, VUV | Pine and juniper |
| D-Arabino Hexonic acid 3-deoxy-2,5,6-tris-O-(TMS)-lactone | C9H10O5 | C18H34O5Si3 | 198.053 | 414.171 | 73, 147, 129, 103, 75 | 1783 | RI, MS | All |
| Syringic acid 2TMS | C9H10O5 | C15H26O5Si2 | 198.053 | 342.132 | 73, 75, 312, 159, 297 | 1890 | RT, MS, VUV, STD | All forms of pine, ground, manzanita, juniper |
| β-Carboline, 7-hydroxy-1-methyl TMS | C12H10ON 2 | C15H18N2OS i | 198.079 | 270.119 | 255, 270, 73, 240, 75 | 1922 | RT, MS, VUV | All forms of pine, juniper |
| Vanillyl glycol 3TMS | C10H14O4 | C19H38O4Si3 | 198.089 | 414.208 | 73, 147, 117, 205, 209 | 1955 | RT, MS, VUV | All forms of pine and juniper |
| Fluoranthene | C16H10 | | 202.078 | | 202, 203, 200, 201, 101 | 2077 | RT, MS, VUV, STD | All |
| Pyrene | C16H10 | | 202.078 | | 202, 200, 203, 201, 101 | 2132 | RT, MS, VUV, STD | All |
| Acephenanthrene | C16H12 | | 204.094 | | 202, 200, 203, 201, 101 | 2101 | RT, MS, VUV | All |
| Pimanthrene | C16H14 | | 206.110 | | 206, 191, 204, 205, 189 | 2058 | RT, MS, VUV | All |
| Anthraquinone | C14H8O2 | | 208.052 | | 208, 152, 180, 76, 151 | 1980 | RT, MS, VUV, STD | Sage, lodgepole pine forms |
| Ethyl homovanillate TMS | C11H19O4 | C14H27O4Si | 215.128 | 287.168 | 252, 179, 209, 73, 282 | 1771 | RT, MS, VUV | Pine litter, duff, rotten log, dung, and grasses |
| Benzofluorene | C17H12 | | 216.094 | | 216 | 2109 | RT, MS, VUV | All forms of pine and shrubs |
| Octanoic acid TMS | C8H16O2 | C11H24O2Si | 216.155 | 144.115 | 73, 75, 117, 201, 131 | 1255 | RT, MS, VUV, STD | All |
| 2, 3-5, 6-dibenzoxalene | C16H10O | | 218.073 | | 218, 73, 189, 91, 219 | 2191 | RI, MS, VUV | Lodgepole |
| Benzo[b]naphtho[1,2-d]furan | C16H10O | | 218.073 | | 218, 189, 219, 204 | 2135 | RT, MS, VUV | Pine, manzanita, sage, bear grass |
| Benzo[k]xanthene | C16H10O | | 218.073 | | 218, 202, 217, 203, 219 | 2203 | RT, MS, VUV | All pine forms |
| Hydroxypyrene | C16H10O | C19H18OSi | 218.073 | 290.113 | 218, 189, 73, 219, 95 | 2152 | RT, MS, VUV | Lodgepole pine |

| | | | | | | | | |
|--------------------------------------------|----------|-------------|---------|---------|-------------------------|------|------------------|-----------------------------------------------|
| Vanillic acid isobutyl ester TMS | C12H16O4 | C15H24O4Si | 224.105 | 296.144 | 241, 256, 225, 73, 242 | 1861 | RT, MS, VUV | All forms of pine, peat, manzanita |
| Cyclopenta[cd]pyrene | C18H10 | | 226.078 | | 226, 224, 227, 113, 225 | 2468 | RT, MS, VUV | Pine, shrubs, bear grass |
| 9-Tetradecenoic acid TMS | C14H26O2 | C17H34O2Si | 226.193 | 298.233 | 73, 75, 117, 283, 129 | 1836 | RT, MS, VUV | Bear grass, duff, pine |
| Chrysene | C18H12 | | 228.094 | | 228, 226, 229, 114, 227 | 2482 | RT, MS, VUV, STD | Pine, shrubs, bear grass |
| Benzanthrone | C17H10O | | 230.073 | | 230, 202, 101, 200 | 2516 | RT, MS, VUV | Lodgepole, pine, and manzanita |
| B-Cyclocostunolide | C15H20O2 | | 232.146 | | 217, 232, 91 | 1928 | RT, VUV | sage, juniper |
| 1-(10-Methylanthracen-9-yl)ethanone | C17H14O | | 234.104 | | 219, 191, 189, 234, 190 | 2405 | RT, MS, VUV | All forms of pine |
| Retene | C18H18 | | 234.141 | | 219, 234, 204, 203, 220 | 2225 | RT, MS, VUV, STD | All |
| Ethylhexyl benzoate | C15H22O2 | | 234.162 | | 105, 70, 77, 112, 83 | 1707 | RT, MS, VUV, STD | All forms of pine and shrubs |
| Heptadecane (C17) | C17H36 | | 240.282 | | 57, 71, 43, 131 | 1698 | RT, MS, VUV, STD | Dung, peat, rice straw, and pine bark |
| Confertin | C15H20O3 | | 248.141 | | 248, 81, 119 | 2043 | RT, MS, VUV | Sage |
| Benzo[a]pyrene | C20H12 | | 252.094 | | 252, 250, 253, 126, 113 | 2886 | RT, MS, VUV, STD | Pine, sage, juniper |
| Benzofluoranthene isomer 1 | C20H12 | | 252.094 | | 252, 253, 250, 125, 126 | 2792 | RT, MS, VUV, STD | Pine, sage, juniper, manzanita |
| Benzofluoranthene isomer 2 | C20H12 | | 252.094 | | 252, 250, 253, 73, 126 | 2873 | RT, MS, VUV, STD | Pine, juniper |
| 11-Hexadecenoic acid TMS | C16H30O2 | C19H38O2Si | 254.225 | 326.264 | 55, 69, 83, 41, 96 | 1938 | RT, MS, VUV | All |
| Palmitic acid TMS | C16H32O2 | C19H40O2Si | 256.240 | 328.280 | 117, 73, 313, 75, 129 | 2042 | RT, MS, VUV, STD | All |
| Nonadecane (C19) | C19H40 | | 268.313 | | 57, 71, 43, 131 | 1897 | RT, MS, VUV, STD | All |
| Heptadecanoic acid TMS | C17H34O2 | C20H42O2Si | 270.256 | 342.295 | 73, 117, 75, 129, 327 | 2112 | RT, MS, VUV, STD | All forms of pine, dung, peat, and bear grass |
| Methyl 13-methylpentadecanoate | C17H34O2 | | 270.256 | | 74, 87, 270 | 1922 | RT, VUV | Pine, ground, and grass |
| Arbutin 4TMS | C12H16O7 | C24H48O7Si4 | 272.090 | 560.248 | 73, 182, 254, 129, 103 | 2563 | RT, MS | Manzanita |

| | | | | | | | | |
|-------------------------------------------------------------|----------|-------------|----------------|---------|----------------------------|------|---------------------|-------------------------------------|
| Divanillyl 2TMS | C16H18O4 | C22H34O4Si2 | 274.12050 9 | 418.200 | 209, 73, 210, 179, 211 | 2468 | RT, MS, VUV | All forms of pine, dung, juniper |
| Dibutyl phthalate | C16H22O4 | | 278.152 | | 149, 57 | 1857 | MS, VUV | All |
| Linoelaidic acid TMS | C18H32O2 | C21H40O2Si | 280.240 | 352.280 | 75, 73, 67, 81, 95 | 2206 | RT, MS, VUV | All |
| Oleic acid TMS | C18H34O2 | C21H42O2Si | 282.256 | 354.295 | 73, 75, 117, 129, 55 | 2220 | RT, MS, VUV | All |
| Icosane (C20) | C20H42 | | 282.329 | | 57, 131, 71, 85 | 1998 | RT, MS, VUV, STD | All |
| Dehydroabietal | C20H28O | | 284.214 | | 159, 269, 173, 209, 241 | 2278 | RT, MS, VUV | All forms of pine |
| Stearic acid TMS | C18H36O2 | C21H44O2Si | 284.272 | 356.311 | 117, 73, 75, 341, 129 | 2238 | RT, MS, VUV, STD | All |
| Isopimaral | C20H30O | | 286.230 | | 187, 131, 105, 91, 145 | 2241 | RT, MS, VUV | Pine and pine litter |
| Henicosane (C21) | C21H44 | | 296.344 | | 57, 131, 71, 43 | 2100 | RT, MS, VUV, STD | All |
| 18-Methyl-nonadecanol TMS | C20H42O | C23H50O2Si | 298.324 | 370.363 | 75, 355, 97, 73, 69 | 2348 | RI, MS, VUV | All forms of pine, grass, sage |
| Dehydroabietic acid TMS | C20H28O2 | C23H36O2Si | 300.209 | 372.248 | 239, 240, 73, 173, 357 | 2386 | RT, MS, VUV | All |
| Abietic acid TMS | C20H30O2 | C23H38O2Si | 302.225 | 374.264 | 256, 241, 185, 213, 73 | 2424 | RT, MS, VUV, STD | Pine and bear grass |
| Isopimaric Acid TMS | C20H30O2 | C23H38O2Si | 302.225 | 374.264 | 241, 73, 242, 359, 105 | 2354 | RT, MS, VUV, STD | All forms of pine |
| Isopimaric acid TMS isomer | C20H30O2 | C23H38O2Si | 302.225 | 374.264 | 241, 256, 73, 257, 242 | 2342 | RT, MS, VUV, STD | All forms of pine and bear grass |
| Pimaric acid TMS | C20H30O2 | C23H38O2Si | 302.225 | 374.264 | 121, 73, 120, 257, 91 | 2307 | RT, MS, VUV | All forms of pine and bear grass |
| Sandaracopimaric acid TMS | C20H30O2 | C23H38O2Si | 302.225 | 374.264 | 73, 121, 120, 119, 81 | 2323 | RT, MS, VUV | All forms of pine and juniper |
| Docosane (C22) | C22H46 | | 310.360 | | 57, 71, 43, 131 | 2199 | RT, MS, VUV, STD | Pine and grass |
| Hexadecanoic acid, 3,7,11,15-tetramethyl TMS | C20H40O2 | C23H48O2Si | 312.303 | 384.342 | 117, 73, 75, 369, 129 | 2438 | RT, MS, VUV | All |
| 7-Oxo-dehydroabietic acid TMS | C20H26O3 | C23H34O3Si | 314.188 | 386.228 | 253, 268, 73, 187, 386 | 2598 | RI, MS, VUV | Pine and bear grass |

| | | | | | | | | |
|----------------------------------------------|----------|-------------|---------|---------|-------------------------|------|------------------|--------------------------------|
| Tricosane (C23) | C23H48 | | 324.376 | | 57, 71, 43, 85 | 2299 | RT, MS, VUV, STD | All |
| 7-Oxodehydroabietic acid methyl ester | C21H28O3 | | 328.204 | | 253, 254, 187, 211, 328 | 2585 | RI, MS, VUV | All forms of pine |
| Tetracosane (C24) | C24H50 | | 338.391 | | 57, 97, 83, 55 | 2393 | RT, MS, VUV, STD | All |
| 3,4-divanillyltetrahydrofuran 2TMS | C20H24O5 | C26H40O5Si2 | 344.162 | 488.241 | 209, 210, 73, 179, 488 | 2981 | RT, MS, VUV | All |
| Pentacosene | C25H50 | | 350.391 | | 83, 57, 97, 43 | 2494 | RT, VUV | Ground, manzanita, bear grass |
| Pentacosane (C25) | C25H52 | | 352.407 | | 57, 71, 131, 85 | 2501 | RT, MS, VUV, STD | All |
| 1-tetracosanol (C24 Alcohol) | C24H50O | C27H58OSi | 354.386 | 426.426 | 75, 411, 97, 57, 412 | 2743 | RT, MS, VUV, STD | All |
| Matairesinol 2TMS | C20H22O6 | C26H38O6Si2 | 358.142 | 502.221 | 209, 73, 179, 210, 502 | 3160 | RT, MS, VUV | Pine, pine litter, and juniper |
| Hexacosene | C26H52 | | 364.407 | | 57, 69, 97, 111, 83 | 2595 | RT, MS, VUV, STD | Ground, manzanita, bear grass |
| Hexacosane (C26) | C26H54 | | 366.423 | | 131, 57, 83, 55 | 2595 | RT, MS, VUV, STD | Pine, ground, and grass |
| Heptacosane (C27) | C27H56 | | 380.438 | | 57, 71, 85, 69, 43 | 2701 | RT, MS, VUV, STD | All |
| Stigmasta-3,5 diene | C29H48 | | 396.376 | | 147, 81, 145, 105, 91 | 3106 | RT, MS, VUV | All |
| Nonacosane (C29) | C29H60 | | 408.470 | | 57, 71, 85, 43, 69 | 2901 | RT, MS, VUV, STD | All |
| β-sitosterol TMS | C29H50O | C32H58OSi | 414.386 | 486.426 | 129, 73, 75, 95, 121 | 3347 | RT, MS, VUV, STD | All |
| 10-nonacosanol TMS | C29H60O | C32H68OSi | 424.464 | 496.504 | 229, 73, 75, 369, 83 | 3062 | RT, MS, VUV, STD | All forms of pine, juniper |
| Tocopherol TMS | C29H50O2 | C32H58O2Si | 430.381 | 502.421 | 237, 73, 236, 502, 238 | 3138 | RT, MS, VUV | All |
| Triacontane (C30) | C30H62 | | 436.501 | | 57, 71, 85, 43 | 3001 | RT, MS, VUV, STD | All |
| Hentriacontane (C31) | C31H64 | | 464.532 | | 57, 71, 85, 69, 43 | 3102 | RT, MS, VUV, STD | All |
| Dotriacontane (C32) | C32H66 | | 492.563 | | 57, 71, 85, 131 | 3202 | RT, MS, VUV, STD | All |

| | | | | | | | | |
|-------------------------------|--------|--|---------|--|-----------------------|------|---------------------|-----|
| Tritriacontane (C33) | C33H68 | | 520.595 | | 57, 71, 69, 43, 85 | 3302 | RT, MS, VUV, STD | All |
| Tetratriacontane (C34) | C34H70 | | 548.626 | | 57, 71, 85, 131 | 3399 | RT, MS, VUV, STD | All |
| Pentatriacontane (C35) | C35H72 | | 576.657 | | 71, 57, 85, 131 | 3500 | RT, MS, VUV, STD | All |

3. Conversion of instrument response to mass loadings and emission factors:

Internal standard was injected onto each sample filter prior to analysis on the TD-GC×GC-EI/VUV-HRToFMS. This was done to correct for matrix effects and slight changes in instrument performance. The internal standard mixture consisted of relevant biomass burning deuterated compounds (see next section). The total volume of each chromatographic peak was integrated and normalized to the nearest internal standard peak volume. The normalized peak volume was then converted to mass loading by finding the nearest standard compound of the same compound class in first and second dimension and using its accompanying mass loadings calibration curve (see next section for more details). In other words, compounds classified as sugars (see SI for more details) were converted to mass loadings based upon the calibration of the nearest sugar standard. Unknown compounds were matched to the nearest standard compound regardless of chemical classification.

Mass loading calibration curves were determined by measuring the instrument's response to varying amounts of 99 standard compounds typically found in biomass burning organic aerosol particles. We estimate the systematic uncertainty in the mass loadings for the unknown compounds at a factor of 2 and unidentified but classified compounds at roughly $\pm 30\%$. This is based upon calculating mass loadings of other standard compounds not included in the 99-compound standard mixture. Sampled compounds that exactly matched a standard compound have a lower uncertainty $\sim \pm 10\%$ primarily due to instrument variation. Since the same data inversion factor was applied to the same observed compound across all samples, these systematic uncertainties do not affect the trends observed in this study but may affect the mass fractions each compound contributes to the total observed mass from a burn.

The background-subtracted compound mass loading was then converted to emission factors by first normalizing to the background-corrected CO₂ mass sampled. CO₂ concentration (by volume) was measured in real-time by the open-path Fourier transform infrared spectroscopy (OP-FTIR). Details of this measurement can be found in Selimovic et al. (2017). The mass of CO₂ that pass through a filter was calculated by first converting the CO₂ volume concentration into mass concentration. CO₂ mass concentration was then numerically integrated over the filter sampling time then multiplied by the total volumetric flow through the filter. The normalized organic compound mass loadings were converted to emission factors, EF_{compound} , via the fire-integrated EF_{CO_2} following the formula below (units are given in parentheses).

$$EF_{\text{compound}} = \frac{\Delta \text{mass of compound (ng)}}{\Delta \text{mass of CO}_2 \text{ (g)}} \times EF_{\text{CO}_2} \text{ (g/kg dry fuel burned)}$$

The Δ indicate change over background. EF_{CO_2} for each burn during FIREX Fire Lab campaign are also presented Selimovic et al. (2018) and were determined by the carbon mass balance method (Ward and Radke, 1993; Yokelson et al., 1996). The carbon mass was summed over the gaseous species detected by the OP-FTIR, with CO₂, CO, and CH₄ accounting for 97-99% of the total emitted carbon. Including the carbon mass of the I/SVOCs would only slightly decrease the EFs reported here and thus their contributions to the carbon mass balance were assumed to be negligible.

4. Internal/external standards and mass loading calibration curves:

A mixture of deuterated internal standards was injected onto every filter prior to analysis. The mixture consisted of 34 compounds that are either found in biomass burning organic aerosols (BBOA) or have functional groups that closely resemble compounds in BBOA. A full list of internal standard compounds is given in Table S2.

Table S2 list of internal standards used on each sample

| Internal Standard Compounds | |
|-----------------------------|------------------------------------|
| d3-vanillin | d4-4-methoxy-benzaldehyde |
| d6-syringic Acid | d8-anthraquinone |
| d8- methylcatechol | d4-phthalic acid |
| d3- vanillic Acid | d5-benzoic acid |
| d4-3-nitrobenzoic Acid | d5-C10 acid |
| d5- 4-hydroxybenzaldehyde | d12-C14 acid |
| d9-1-nitropyrene | d31-C16 acid |
| d26-C12 alkane | d35-C18 acid |
| d28-C13 alkane | d43-C22 acid |
| d30-C14 alkane | d7-cholesterol |
| d34-C16 alkane | d5-Cholestane |
| d38-C18 alkane | d5-3-hydroxy-1,5-pentanedioic acid |
| d42-C20 alkane | C6 diacid |
| d46-C22 alkane | d31-pentadecanol |
| d50-C24 alkane | 6^{13}C -glucose |
| d54-C26 alkane | 2^{13}C -pentaerythritol |
| d58-C28 alkane | d10-pyrene |
| d62-C30 alkane | d10-phenanthrene |
| d66-C32 alkane | d12-perylene |
| d70-C34 alkane | d12-chrysene |
| d74-C36 alkane | d14-dibenzanthracene |

A more extensive mixture of standards was used to calibrate the mass loading sensitivity of the TD-GC×GC EI-HRTofMS directly after all the Fire Lab samples were run. This mixture of external standards contained 99 compounds that have been previously observed in biomass burning emissions. These compounds represent all the compound families as described in the main paper and are given in Table S3. Various mass loadings were injected onto separate blank quartz fiber filters and analyzed with the TD-GC×GC EI-HRTofMS. The volume ratio between the total external standard peak and the nearest total internal standard peak were then correlated to the respective mass loading ratio. Example mass loading calibration curves are shown in Figure S3. In general, the linearity between mass loading and instrument response was good ($R^2 > 0.9$) over a wide range of normalized mass loadings; this may not be true at extremely low and high mass loadings for some compounds. Measured levoglucosan mass loadings did exceed the upper limits of the calibration curve for some of the conifer burns; in these cases, the calibration curve was extrapolated and may lead to higher uncertainty in levoglucosan EFs. Furthermore, several PAH external standard compounds showed poor linearity because their peaks in the chromatogram co-eluted with the nearest internal standard peak at high mass

loadings. These high mass loading points were not taken into account for the calibration curve. This assumption is valid as the volumes of the PAH peaks were not observed during the FSL experiments to be within this high mass loading range.

Table S3 List of external standards used to determine the mass loading calibration curve of the TD-GC×GC-EI-HRToFMS

| External Standard Compounds | | | |
|---------------------------------------|----------------------------|---------------------|-------------------------------------|
| Cholesterol | Retene | C7 carboxylic acid | C12 alkane |
| Stigmasterol | Naphthalene | C8 carboxylic acid | C13 alkane |
| β-sitosterol | Phenanthrene | C9 carboxylic acid | C14 alkane |
| Ergosterol | Pyrene | C10 carboxylic acid | C15 alkane |
| α-Amyrin | Acenaphthene | C11 carboxylic acid | C16 alkane |
| Levogluconan | Acenaphthylene | C12 carboxylic acid | C17 alkane |
| Levogluconenone | Anthracene | C13 carboxylic acid | Pentadecane, 2,6,10,14-tetramethyl- |
| Mannosan | 1,2-Benzanthracene | C14 carboxylic acid | C18 alkane |
| Galactosan | Benzo(a)pyrene | C15 carboxylic acid | Hexadecane, 2,6,10,14-tetramethyl- |
| Guaiacol | Benzo(b)fluoranthene | C16 carboxylic acid | C19 alkane |
| Syringol (2,6-Dimethoxyphenol) | Benzo(g,h,i)perylene | C17 carboxylic acid | C20 alkane |
| Syringic Acid | Benzo(k)fluoranthene | C18 carboxylic acid | C21 alkane |
| Syringaldehyde | Chrysene | C20 carboxylic acid | C22 alkane |
| Sinapinaldehyde | Dibenz(a,h)anthracene | C22 carboxylic acid | C23 alkane |
| Vanillin | Fluoranthene | C23 carboxylic acid | C24 alkane |
| Vanillic acid | Fluorene | C24 carboxylic acid | C25 alkane |
| 4-hydroxybenzoic acid | Indeno(1,2,3-cd)pyrene | C26 carboxylic acid | C26 alkane |
| p-Anisic acid (4-methoxybenzoic acid) | Maltol | C28 carboxylic acid | C27 alkane |
| 3,5-dimethoxyphenol | 5-(Hydroxymethyl) furfural | D-(+)-glucose | C28 alkane |
| Phthalic acid | 4-Nitrocatechol | D-(+)-mannose | C29 alkane |
| Abietic acid | 5-Nitrovanillin | L-(-)-mannose | C30 alkane |
| Isopimaric acid | 2,4-Dinitrophenol | D-(+)-galactose | C31 alkane |
| Resorcinol | | D-Pinitol | C32 alkane |
| Hydroquinone | | Pyrocatechol | C33 alkane |
| 4-Methylcatechol | | | C34 alkane |

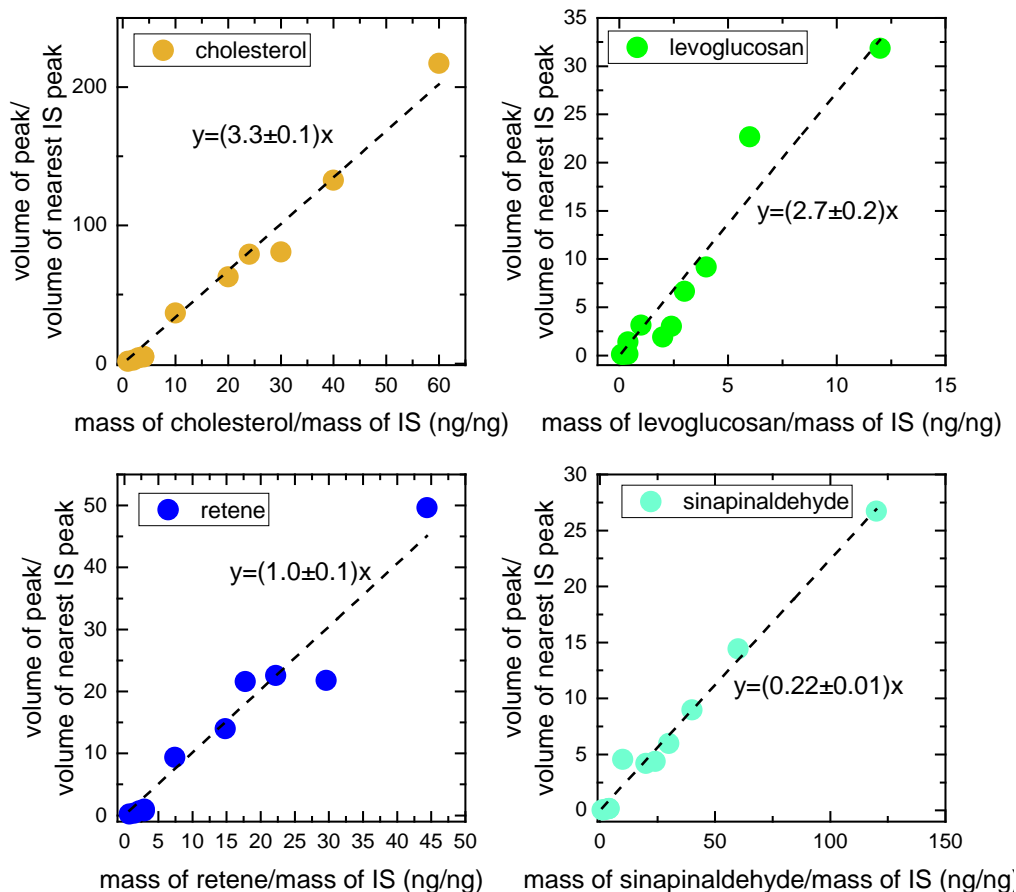
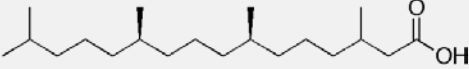
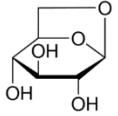
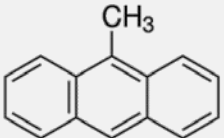
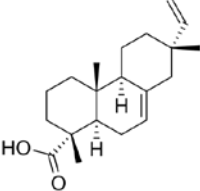
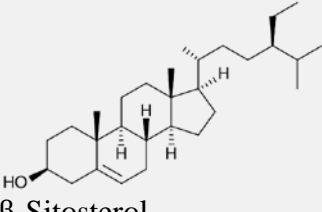
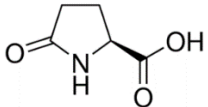
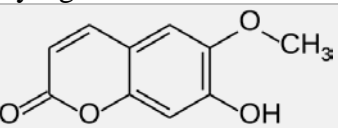
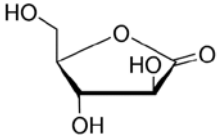
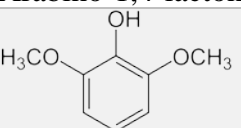

Figure S3 Example mass loading calibration curves for cholesterol, levoglucosan, retene, and sinapinaldehyde. Each external standard compound is normalized to the nearest internal standard (IS) compound. Colors are coded based upon the broad compound family: cholesterol=sterol, levoglucosan=sugar, retene=PAH, and sinapinaldehyde=methoxyphenol

5. Classifying unidentified compounds into chemical families:

The 1D RI and the 2D retention time of an unidentified compound were first examined to ballpark potential family choices. Larger molecules like sterols have lower vapor pressures, and thus higher RI, than sugars. Derivatized methoxyphenols are more polar than derivatized sugars but have similar vapor pressures; therefore, methoxyphenols elute later in the second dimension than sugars. After the possible families were narrowed down, the electron ionization (EI) mass spectrum of the unidentified compound was then analyzed for specific ions and patterns that signify particular functional groups. For example, derivatized sugars exhibit 204 and 217 m/z and PAHs show little fragmentation. Derivatized sugars also show significant fragmentation with vacuum ultra violet light (VUV) ionization, making them easier to distinguish from compounds with benzene rings in the VUV mass spectrum. Each of the ~3000 compounds, including identified compounds, were analyzed using this method and placed into a family. Example compounds for each category are given in Table S3. The bulk of the unidentified compounds could not be placed into a category and remain unknown. More work needs to be done to synthesize standards of a wider variety of compounds in order to better identify/classify the unknown compounds.

Table S4 List of chemical families and examples for each family (without derivatization)

| Family Name | Example compound (underivatized) |
|---------------------------------|-------------------------------------------------------------------------------------------------------------------------------|
| Non-cyclic aliphatic/oxygenated |  3,7,11,15-tetramethyl hexadecanoic acid |
| Sugars |  Levoglucosan |
| PAHs/methyl/oxygenated |  1-Methylanthracene |
| Resin acids/diterpenoids |  Isopimaric acid |
| Sterols/triterpenoids |  β -Sitosterol |
| Organic nitrogen |  Pyroglutamic acid |
| Aromatic oxygen heterocycles |  Scopoletin |
| Oxygenated cyclic alkanes |  Arabino-1,4-lactone |
| Methoxyphenols |  Syringol |

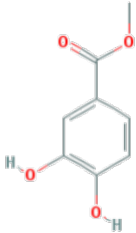
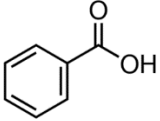
| | |
|---------------------------|-------------------------------------------------------------------------------------------------------------------|
| Substituted phenols |  Methyl 3-4-dihydroxybenzoate |
| Substituted benzoic acids |  Benzoic Acid |

6. Classified I/SVOC mass fractions averaged over fuel type

The average mass fractions of total observed I/SVOCs for the chemical families across each fuel types (see Figure 3) are given in Table S5.

Table S5 Mass fraction (in %) and standard deviation of each of the chemical families for the various fuel types.

| | Shrubs | Grass | Wood | Coniferous Litter | Conifers | Peat | Dung | Coniferous Duff | Woody Debris |
|---------------------------|---------|---------|----------|-------------------|----------|-------|-------|-----------------|--------------|
| Unknown | 50%, 5% | 59%, 6% | 52%, 14% | 48%, 9% | 57%, 13% | 50% | 50% | 59%, 15% | 88%, 1% |
| Non-cyclic aliphatics/oxy | 12%, 9% | 8%, 2% | 8%, 2% | 7%, 2% | 6%, 2% | 26% | 9% | 9%, 2% | 1%, 0% |
| Sugars | 12%, 3% | 12%, 2% | 21%, 8% | 15%, 6% | 18%, 10% | 3% | 14% | 9%, 6% | 5%, 1% |
| PAH/methyl+oxy | 1%, 1% | 0%, 0% | 1%, 1% | 2%, 0% | 1%, 0% | 1% | 0% | 2%, 0% | 1%, 0% |
| Resin acids/diterpenoids | 0%, 0% | 0%, 0% | 0%, 0% | 8%, 1% | 3%, 2% | 0% | 0% | 3%, 2% | 0%, 0% |
| Sterols, triterpenoids | 1%, 0% | 0%, 0% | 0%, 0% | 1%, 0% | 0%, 0% | 0% | 1% | 0%, 0% | 0%, 0% |
| Organic nitrogen | 13%, 8% | 12%, 1% | 8%, 4% | 14%, 1% | 10%, 5% | 15% | 22% | 11%, 6% | 1%, 1% |
| Oxy aromatic heterocycles | 1%, 2% | 1%, 0% | 1%, 0% | 0%, 0% | 1%, 0% | 0% | 0% | 0%, 1% | 0%, 0% |
| Oxy cyclics | 0%, 0% | 3%, 2% | 0%, 0% | 1%, 0% | 1%, 1% | 0% | 1% | 1%, 1% | 0%, 0% |
| Methoxyphenols | 3%, 1% | 3%, 2% | 7%, 3% | 3%, 0% | 2%, 1% | 4% | 3% | 4%, 1% | 3%, 1% |
| Substituted phenols | 7%, % | 1%, 0% | 0%, 0% | 1%, 0% | 1%, 1% | 1% | 1% | 1%, 0% | 0%, 0% |
| Substituted benzoic acids | 1%, 1% | 0%, 0% | 0%, 0% | 0%, 0% | 0%, 0% | 0% | 0% | 0%, 0% | 0%, 0% |
| Average MCE. | 0.958 | 0.898 | 0.958 | 0.955 | 0.931 | 0.840 | 0.902 | 0.871 | 0.878 |

7. EFs for families of compounds as a function of MCE:

Emission factors for each of the 12 families (including unknowns) were summed together in each fire-integrated sample. Figure S4 displays all of the family EFs as a function of modified combustion efficiency (MCE). This figure is an expansion of Figure 4 in the main paper. EFs for all chemical families exhibit a clear dependence on MCE, with smoldering burns producing 2-4 orders of magnitude more I/SVOC emissions. Logarithmic fits of the form $\log(\text{EF}) = \text{slope}(\text{MCE}) + \text{int}$ were also applied to these observations with the fit parameters displayed on each of the panels.

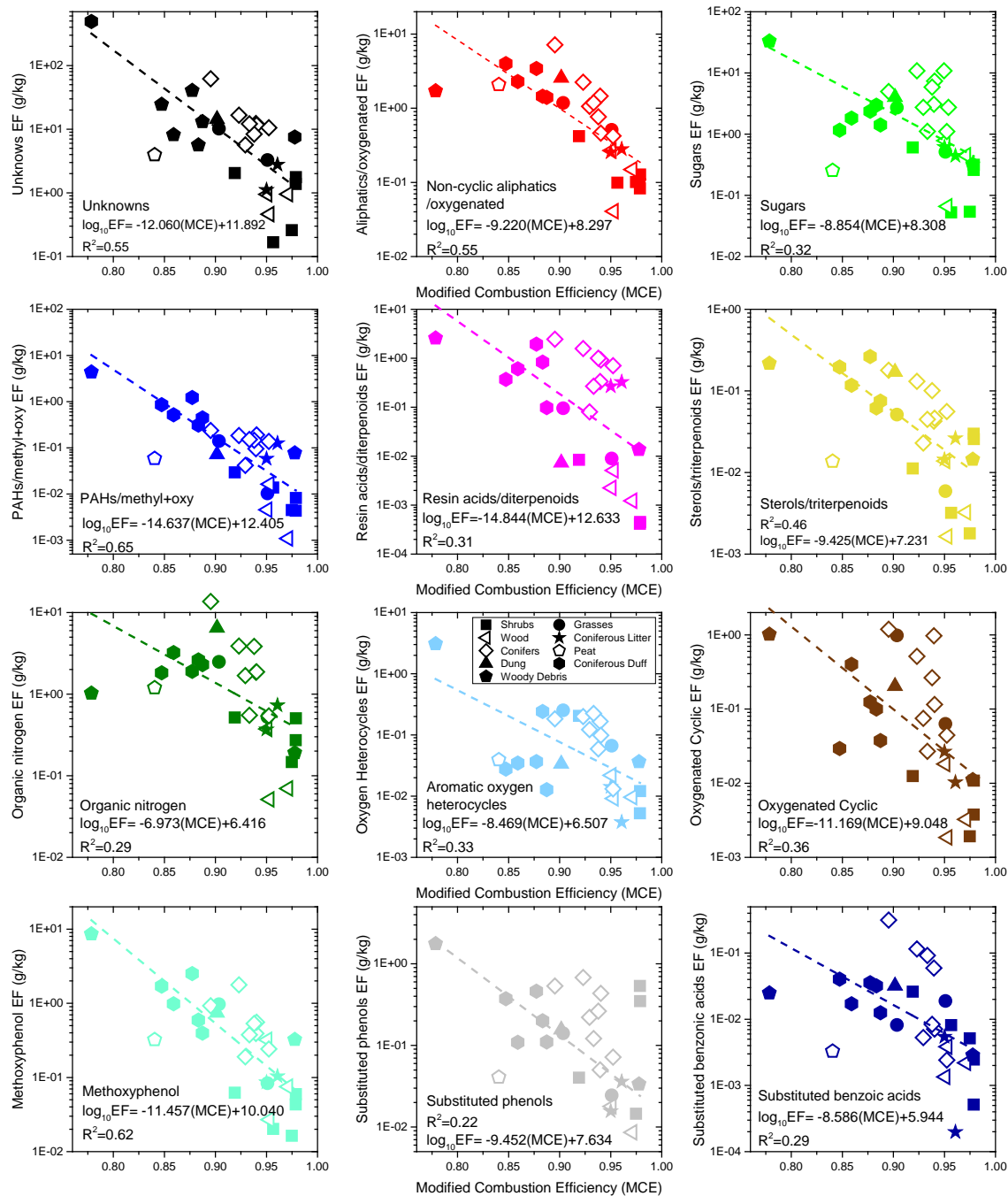

Figure S4 Emission factors (EFs) of each of the 12 chemical families as a function of modified combustion efficiency (MCE). Each panel/color represents a different chemical family and the different symbols show the different fuel types. Dashed lines are of the $\log_{10}(EF) = \text{slope}(MCE) + \text{int}$ fits with the parameters provided in the panel. Note, peat (open pentagon) was not included in the fits except for non-cyclics aliphatic/oxy (red).

Table S6 Logarithmic fit parameters for each of the chemical families and total I/SVOCs

| Chemical Family | Slope ± error | Intercept ± error |
|----------------------------------|----------------------|--------------------------|
| Total | -11.44858 ± 1.87 | 11.58506 ± 1.74 |
| Unknown | - 12.05974 ± 2.05 | 11.8919± 1.90 |
| Non-cyclic Aliphatic/Oxy | -9.21952 ± 1.54 | 8.29706 ± 1.42 |
| Sugars | -8.85359 ± 2.29 | 8.30773 ± 2.12 |
| PAH/methyl+oxy | -14.63717± 2.07 | 12.40498± 1.91 |
| Resin Acids/diterpenoids | -14.84408 ± 4.22 | 12.63297 ± 3.90 |
| Sterols/triterpenoids | -9.42488 ± 1.93 | 7.23105 ± 1.79 |
| Organic Nitrogen | -6.97334 ± 2.07 | 6.41579 ± 1.91 |
| Oxy Aromatic Heterocycles | -8.46896 ± 2.33 | 6.50727 ± 2.15 |
| Oxygenated Cyclic | -11.1686 ± 2.84 | 9.04829 ± 2.63 |
| Methoxyphenol | -11.45675 ± 1.72 | 10.03962 ± 1.59 |
| Substituted Phenol | -9.45183 ± 3.22 | 7.63392 ± 2.98 |
| Substituted Benzoic Acid | -8.58551 ± 2.49 | 5.9437 ± 2.30 |

Works Cited:

Selimovic, V., Yokelson, R. J., Warneke, C., Roberts, J. M., de Gouw, J., Reardon, J. and Griffith, D. W. T.: Aerosol optical properties and trace gas emissions by PAX and OP-FTIR for laboratory-simulated western US wildfires during FIREX, Atmos Chem Phys Discuss, 2017, 1–34, doi:10.5194/acp-2017-859, 2017.

Selimovic, V., Yokelson, R. J., Warneke, C., Roberts, J. M., de Gouw, J., Reardon, J. and Griffith, D. W. T.: Aerosol optical properties and trace gas emissions by PAX and OP-FTIR for laboratory-simulated western US wildfires during FIREX, Atmos Chem Phys, 18(4), 2929–2948, doi:10.5194/acp-18-2929-2018, 2018.

Ward, D. E. and Radke, L. F.: Emissions measurements from vegetation fires: A comparative evaluation of methods and results, Crutzen P J Goldammer J G Eds Fire Environ. Ecol. Atmospheric Clim. Importance Veg. Fires Dahl. Workshop Rep. Environ. Sci. Res. Rep. 13 Chichester Engl. John Wiley Sons P 53-76, 53–76, 1993.

Williams, B. J., Goldstein, A. H., Kreisberg, N. M. and Hering, S. V.: An in-situ instrument for speciated organic composition of atmospheric aerosols: Thermal Desorption Aerosol GC/MS-FID (TAG), Aerosol Sci. Technol., 40, 627–638, doi:10.1080/02786820600754631, 2006.

Yokelson, R. J., Griffith, D. W. T. and Ward, D. E.: Open-path Fourier transform infrared studies of large-scale laboratory biomass fires, J. Geophys. Res. Atmospheres, 101(D15), 21067–21080, doi:10.1029/96JD01800, 1996.