

**A new database of
trace gases and
aerosols**

B. Hassler et al.

Technical Note: A new global database of trace gases and aerosols from multiple sources of high vertical resolution measurements

B. Hassler¹, G. E. Bodeker², and M. Dameris³

¹Meteorological Institute, University of Munich, Munich, Germany

²National Institute of Water and Atmospheric Research, Lauder, New Zealand

³Deutsches Zentrum für Luft- und Raumfahrt, Institut für Physik der Atmosphäre, Oberpfaffenhofen, Germany

Received: 20 February 2008 – Accepted: 25 March 2008 – Published: 18 April 2008

Correspondence to: B. Hassler (b.hassler@niwa.co.nz)

Published by Copernicus Publications on behalf of the European Geosciences Union.

Title Page

Abstract

Introduction

Conclusions

References

Tables

Figures

◀

▶

◀

▶

Back

Close

Full Screen / Esc

Printer-friendly Version

Interactive Discussion



Abstract

A new database of trace gases and aerosols with global coverage, derived from high vertical resolution profile measurements, has been assembled as a collection of binary data files; hereafter referred to as the “Binary DataBase of Profiles” (BDBP). Version 1.0 of the BDBP, described here, includes measurements from different satellite- (HALOE, POAM II and III, SAGE I and II) and ground-based measurement systems (ozonesondes). In addition to the primary product of ozone, secondary measurements of other trace gases, aerosol extinction, and temperature are included. All data are subjected to very strict quality control and for every measurement a percentage error on the measurement is included. To facilitate analyses, each measurement is added to 3 different instances (3 different grids) of the database where measurements are indexed by: (1) geographic latitude, longitude, altitude (in 1 km steps) and time, (2) geographic latitude, longitude, pressure (at levels ~ 1 km apart) and time, (3) equivalent latitude, potential temperature (8 levels from 300 K to 650 K) and time.

In contrast to existing zonal mean databases, by including a wider range of measurement sources (both satellite and ozonesondes), the BDBP is sufficiently dense to permit calculation of changes in ozone by latitude, longitude and altitude. In addition, by including other trace gases such as water vapour, this database can be used for comprehensive radiative transfer calculations. By providing the original measurements rather than derived monthly means, the BDBP is applicable to a wider range of applications than databases containing only monthly mean data. Monthly mean zonal mean ozone concentrations calculated from the BDBP are compared with the database of Randel and Wu, which has been used in many earlier analyses. As opposed to that database which is generated from regression model fits, the BDBP uses the original (quality controlled) measurements with no smoothing applied in any way and as a result displays higher natural variability.

ACPD

8, 7657–7702, 2008

A new database of trace gases and aerosols

B. Hassler et al.

Title Page

Abstract

Introduction

Conclusions

References

Tables

Figures

◀

▶

◀

▶

Back

Close

Full Screen / Esc

Printer-friendly Version

Interactive Discussion



1 Introduction

Ozone is a greenhouse gas and as such past and future changes in ozone drive changes in radiative forcing of the climate system. To incorporate these changes in radiative forcing by ozone, global climate models require ozone boundary conditions that span the atmosphere from the surface to the lower mesosphere (0–70 km), from pole to pole, and at high vertical resolution, e.g. to resolve changes in ozone close to the tropopause where the effect on radiative forcing is largest (Forster and Shine, 1997). Furthermore, if zonal asymmetries in the ozone changes can be included, this results in a more accurate representation of changes in radiative forcing.

A vertically resolved ozone database with sufficient density to detect changes in ozone as a function of latitude, longitude and altitude, is valuable for attributing past changes in ozone e.g. zonal asymmetry in ozone trends may be indicative of the influence of changes in dynamics. Such a database is also valuable for the evaluation of chemistry-climate models and in particular for validating the ability of these models to reproduce the latitude-altitude structure in past ozone changes.

There are two commonly used vertical ozone profile databases currently available (Fortuin and Kelder, 1998; Randel and Wu, 2007). However, both report monthly mean zonal mean data only, with no longitudinal resolution. The BDBP is not a zonal mean database and individual measurement sets are archived. A measurement set is a group of measurements made at the same date, time, latitude, longitude, altitude and from the same instrument. As a result, the BDBP can be used to extract ozone profiles for a specified location.

In Randel and Wu (2007) no changes in tropospheric ozone are reported and ozonesondes are used only from Syowa and Resolute. These ozonesonde measurements are used to infer changes in ozone poleward of 60° latitude. Because Syowa (69° S) is close to the Antarctic vortex edge, meridional movements of the vortex result in Syowa ozonesondes sampling air from both inside and outside the vortex and therefore decreases in ozone over the Antarctic are likely underestimated.

ACPD

8, 7657–7702, 2008

A new database of trace gases and aerosols

B. Hassler et al.

Title Page

Abstract

Introduction

Conclusions

References

Tables

Figures

◀

▶

◀

▶

Back

Close

Full Screen / Esc

Printer-friendly Version

Interactive Discussion



**A new database of
trace gases and
aerosols**B. Hassler et al.

[Title Page](#)[Abstract](#)[Introduction](#)[Conclusions](#)[References](#)[Tables](#)[Figures](#)[⏪](#)[⏩](#)[◀](#)[▶](#)[Back](#)[Close](#)[Full Screen / Esc](#)[Printer-friendly Version](#)[Interactive Discussion](#)

Fortuin and Kelder (1998) built their database using ozonesonde profiles from selected stations and SBUV-SBUV/2 measurements from 1980 to 1991, mainly to provide an ozone climatology for global climate model simulations. For the BDBP many more ozonesonde stations were available providing a greater degree of coverage. Furthermore, longer periods of data were available for the ozonesonde stations, and therefore a considerably longer time period for this database could be achieved. In addition, the high vertical resolution of the BDBP allows more detailed analyses of vertical ozone structures compared to the 19 pressure levels in the Fortuin and Kelder database.

The BDBP has been implemented in a flexible and extensible data file format structured for rapid extraction of data. Three different instances of the database have been created where measurements are indexed by: (1) geographic latitude, longitude, altitude (in 1 km steps) and time, (2) geographic latitude, longitude, pressure (at levels ~1 km apart) and time, (3) equivalent latitude (Butchart and Remsberg, 1986), potential temperature (8 levels from 300 K to 650 K) and time (see Sect. 2). A detailed description of the different data sources from which measurements have been added to Version 1 of the BDBP is given in Sect. 3. By including data from as many sources as possible, dense coverage of the globe, at high temporal resolution, is achieved. The spatial and temporal coverage of the database is quantified in Sect. 4. Monthly mean 2° zonal mean ozone concentrations were extracted from the BDBP and are compared with the data set of Randel and Wu (2007) in Sect. 5. Section 6 then shows some examples from the BDBP of O₃, NO₂ and H₂O for one (or more) specified level(s) and a defined latitude region. Finally, in Sect. 6, the advantages of the BDBP over other existing databases are highlighted and suggestions are made for possible applications of the BDBP.

2 Database structure

To facilitate analysis of the BDBP, three different instances of the database were assembled, each comprising a 3-dimensional data grid (Fig. 1).

A new database of trace gases and aerosols

B. Hassler et al.

Title Page

Abstract

Introduction

Conclusions

References

Tables

Figures

◀

▶

◀

▶

Back

Close

Full Screen / Esc

Printer-friendly Version

Interactive Discussion



In all cases one of the dimensions is time. The other two dimensions are: in Grid I, geographical latitude and altitude, in Grid II, geographical latitude and pressure, and in Grid III, equivalent latitude and potential temperature. The data are stored within the grids as “measurement sets”. A measurement set is a collection of measurements made at the same date and time, latitude, longitude, and altitude, from the same instrument, which are stored together with the source of the measurement set (e.g. “SAGE2 V6.2”). Each grid contains the same source data but gridded in three different ways to provide different meridional slices of the database. For example, in Grid III, binning the data by equivalent latitude and potential temperature preserves the steep meridional gradients in any zonal means calculated from the database, e.g. close to the vortex edge. In the other two grids these would be smeared out as a consequence of averaging data inside and outside the vortex on lines of constant latitude. For each grid, the data are stored in 90 files, each of which span 2° in geographic latitude or, for Grid III, 2° of equivalent latitude, for convenience. Grid I has 70 altitude levels extending from 1 km to 70 km in 1 km steps, and the measurements have been interpolated to these levels (as discussed further below). Grid II has 70 pressure levels spaced approximately 1 km apart given by:

$$p_n = p_0 e^{-n/7}, n = 1..70 \quad (1)$$

where $p_0 = 1013.25$ hPa.

The pressure levels are exactly 1 km apart when the scale height (RT/g) is 7 km ($R = 286.9$ N m kg⁻¹ K⁻¹, $g = 9.8$ m s⁻¹). Grid III has 8 potential temperature levels at 300, 315, 330, 350, 400, 450, 550, and 650 K matching the standard output levels of the NCEP/NCAR potential temperature database (<http://dss.ucar.edu/datasets/ds090.0/>). The lowest levels of 270, 280, and 290 K were excluded because these levels intersect the Earth’s surface and confound the calculation of equivalent latitude. Meridional profiles of potential vorticity (PV) by equivalent latitude (see Fig. 1a of [Nash et al., 1996](#)) were calculated from NCEP/NCAR reanalyses ([Kistler et al., 2001](#)) every 6 h on the 8 isentropic levels listed above. The equivalent latitude for a given measurement set

on a given isentropic level is calculated by taking the PV at the measurement latitude and longitude, and, using the meridional profile of PV vs. equivalent latitude at the nearest 6 h mark, the equivalent latitude is linearly interpolated using the PV value. Grid III in version 1.0 of the BDBP has no data before 1978 since equivalent latitudes before 1978 were not available.

Each measurement comprises a value, an error in percent, and a data descriptor (e.g. "Ozone"). The length of each measurement set varies according to the number of measurements available. In this way, the grids are kept compact since no null values need to be stored. If the source data are in the form of vertical profiles, values are interpolated onto the pre-defined vertical levels with the result that the profile is no longer kept as a single entity within the grid. Each measurement set has its own unique time stamp and therefore the measurement sets at a given altitude and latitude bin need not be equally spaced in time (see Fig. 1).

The two primary target variables for this version of the BDBP are ozone and temperature and the data sources used have been selected to optimize the spatial and temporal coverage for these variables. Where other coincident measurements (e.g. NO₂ or H₂O) are available from the data sources, these have been added to the grids. The variables included in the BDBP, together with their data sources, are listed in Table 1.

3 Data sources

Criteria for the selection of source data for this version of the BDBP were:

1. Only profile data are considered and only profiles with high vertical resolution (i.e. better than ~1.5 km). Two data sources fulfilling these criteria are solar occultation satellite-based instruments and ozonesondes. Lidar and aircraft profile measurements would also have been suitable but were not included in this version of the BDBP since we required coincident temperature and/or pressure measurements

A new database of trace gases and aerosols

B. Hassler et al.

Title Page

Abstract

Introduction

Conclusions

References

Tables

Figures

◀

▶

◀

▶

Back

Close

Full Screen / Esc

Printer-friendly Version

Interactive Discussion



A new database of trace gases and aerosols

B. Hassler et al.

Title Page

Abstract

Introduction

Conclusions

References

Tables

Figures

◀

▶

◀

▶

Back

Close

Full Screen / Esc

Printer-friendly Version

Interactive Discussion



to permit the data to be included in Grids II and III and these were not always available. Furthermore, these data sources would not have added significant quantities of data to the BDBP.

2. All measurements must include an indication of measurement precision and the measurement errors should preferably be small.
3. Source data spanning longer periods were given higher priority.
4. Measurements covering a data sparse region of the globe were given high priority.

These criteria led to the use of HALOE, SAGE I, SAGE II, POAM II, POAM III and ozonesondes as data sources for this version of the BDBP. The specifics concerning the addition of each of these data sources are given in Sects. 3.1 to 3.4.

3.1 SAGE I and II

3.1.1 SAGE I and II instrument and data information

Both Stratospheric Aerosol and Gas Experiment (SAGE) instruments were built and launched by NASA (see for example McCormick et al., 1989; Cunnold et al., 1989; Nazaryan and McCormick, 2005; Liu et al., 2006). Version 6.1 SAGE I data were provided by L. W. Thomason (NASA; personal communication). The SAGE I measurements start in February 1979 and stop in November 1981 spanning 79° S to 79° N.

Version 6.2 SAGE II data were used (Wang et al., 2006, http://eosweb.larc.nasa.gov/project/sage2/table_sage2.html) which started in October 1984 and ended in August 2005. The spatial coverage spans 80° S to 80° N (see Table 2), although coverage can be sparse at higher latitudes depending on season (Wang et al., 2002).

Measurement errors for SAGE I and SAGE II, included in the BDBP, are given in the source data files and are calculated by accounting for all known sources of uncertainty in the measurement. For both SAGE I and II the temperature and pressure values

included in the data files were not retrieved parameters, but were provided by the National Meteorological Center (NMC). Nevertheless they were used to determine the levels at which the data were inserted into Grid II and Grid III, and were also included as measurements within each measurement set.

5 Since both SAGE I and SAGE II measure trace gas profiles with the solar occultation method, an additional identifier specifying whether the measurement was made at sunrise or sunset was included in each SAGE measurement set.

3.1.2 Altitude correction for SAGE I data

There is a known altitude error in SAGE I observations (Veiga et al., 1995). Wang et al. (1996) discuss and analyse this error in detail. To correct for this error in the SAGE I data, an altitude correction based on Fig. 3 of Wang et al. (1996) was performed. Altitudes for every profile measured between 60° N and 60° S were shifted upwards by an offset dependent on latitude but independent on altitude i.e. the measured profiles are shifted rigidly upwards. Although Wang et al. (1996) only discuss the altitude error for ozone profiles, the correction was applied to all measurements. Pressure and temperature values were assumed to be correct since they were provided from NMC directly (Wang et al., 1996) and therefore the pressure profiles were not shifted.

3.1.3 Screening of SAGE I data

There are few publications, if any, that describe how best to screen SAGE I data to remove outliers. Therefore, in this analysis, data quality controls, similar to those performed for the SAGE II data (described below), were applied to remove outliers from the O₃ and NO₂ data. Particularly below 15 km, measurements of O₃ and NO₂ can be affected by aerosols. Therefore, measurements of O₃ and NO₂ were removed if the aerosol extinction at 1000 nm was higher than 0.001/km (L.W. Thomason, NASA, personal communication). Nevertheless, the utility of the SAGE I data below 15 km is limited to qualitative rather than quantitative analyses (e.g. looking for geographical

**A new database of
trace gases and
aerosols**

B. Hassler et al.

Title Page

Abstract

Introduction

Conclusions

References

Tables

Figures

◀

▶

◀

▶

Back

Close

Full Screen / Esc

Printer-friendly Version

Interactive Discussion



regions of enhanced upper tropospheric ozone). These data are retained in the BDBP with their high error values to allow later screening.

3.1.4 Screening of SAGE II data

Rind et al. (2005) showed that O₃, NO₂ and H₂O measurements from SAGE II are affected by interference from aerosols and clouds. Since the original SAGE II data are only available in an unscreened version (although they are provided with quality flags for unreliable data) additional treatment of the data was necessary to ensure the highest possible quality. The screening was performed following the suggestions of Wang et al. (1996) and Rind et al. (2005). Data points or whole profiles were removed if the following checks were true:

For O₃ specifically:

- From the time when the beta angle of the spacecraft (the angle between the satellite orbit plane and the Earth to Sun vector) exceeds 60° until it returns to less than 40° all profiles are excluded.
- All measurements below 23 km from July 1991 to October 1993 are excluded to avoid the confounding effects of the Mt. Pinatubo eruption.
- Measurements between 23 June 1993 and 11 April 1994, between 30 km and 50 km are excluded whenever the quoted measurement error exceeds 10%.
- Measurements between 10.5 km and 24.5 km are excluded if the ozone mixing ratio exceeds 10 ppm.
- Measurements above 25 km are excluded if values are >100 ppm.
- Measurements at altitudes above 3 hPa are excluded if values are >50 ppm.
- Measurements in the mid- to upper troposphere are excluded when clouds are present as denoted by the cloud quality flags in the data files.

For NO₂ specifically:

- If the 1020 nm aerosol absorption is greater than $7 \times 10^{-4} \text{ km}^{-1}$ the measurement is excluded.

**A new database of
trace gases and
aerosols**

B. Hassler et al.

Title Page

Abstract

Introduction

Conclusions

References

Tables

Figures

◀

▶

◀

▶

Back

Close

Full Screen / Esc

Printer-friendly Version

Interactive Discussion



For H₂O specifically:

- If the relative humidity exceeds 100% or is less than 0% the measurement is excluded.
- If clouds are present anywhere between 6 and 25.5 km (as denoted by the cloud identifier flags) the water vapour measurement at the altitude of the flagged clouds is omitted.
- Above the tropopause, if the aerosol absorption at 1020 nm exceeds $4 \times 10^{-4} \text{ km}^{-1}$ the water vapour measurement is excluded.
- If the optical depth at 1020 nm is large (as denoted by the quality flags) the measurement is excluded.
- If the H₂O slow convergence flag is set, the measurement is excluded.

For all aerosol extinction measurements:

- If the “T-C inversion routine failure for the screened aerosol extinction retrieval” is set, the measurement is excluded.
- If the “cloud test not successful” flag is set, the measurement is excluded.

Furthermore:

- For NO₂ and H₂O, all measurements between 23 June 1993 and 10 April 1994, at altitudes above 30 hPa are excluded.
- For NO₂ and H₂O, all measurements in November 1991, September 1992 and October 1992 at altitude below 150 hPa are excluded.
- For O₃ and H₂O, all measurements in the first 6 km are removed when there is large absorption (integrated value above that level bigger than about 5%) in the 1020 nm channel.
- For O₃, NO₂ and H₂O, if the measurement is more than 10σ away from the monthly mean value for that latitude (15° zones), longitude (90° quadrants) and altitude (0.5 km grid), the measurement is excluded.

**A new database of
trace gases and
aerosols**

B. Hassler et al.

Title Page

Abstract

Introduction

Conclusions

References

Tables

Figures

◀

▶

◀

▶

Back

Close

Full Screen / Esc

Printer-friendly Version

Interactive Discussion



The climatology and statistics needed to perform the last test were calculated separately for each of the 3 species as area weighted means from the unscreened SAGE II data.

3.2 HALOE

5 The Halogen Occultation Experiment (HALOE) was launched in September 1991 as a NASA project. Measurements are available from October 1991 until November 2005 in the latest Version 19. HALOE uses solar occultation to simultaneously measure, amongst others, vertical profiles of O₃, HCl, HF, CH₄, H₂O, NO, NO₂ and temperature which are added to the BDBP. The altitude range of the measurements extends from
10 ~15 km to 60–130 km, depending on the species (see Table 3). Although the vertical resolution of the profiles is ~1.6 km, the data were included in the BDBP since these measurements provide good global coverage and have been used in numerous previous studies (McKenna et al., 2002; Steil et al., 2003; Remsberg and Deaver, 2005). For every measurement a measurement error is also provided in the source data files and these are added to the BDBP. A sunrise/sunset identifier is also included in each
15 measurement set. HALOE data are already screened for cirrus cloud contamination, described in Hervig and McHugh (1999), and therefore no additional screening of the data was done. A detailed analysis of the HALOE ozone data quality (Version 18) is presented in Bhatt et al. (1999). For a more detailed HALOE data description see
20 Russell et al. (1993).

3.3 POAM II and III

The Polar Ozone and Aerosol Measurement II (POAM II) instrument was developed by the Naval Research Laboratory (NRL) to measure the vertical distribution of atmospheric O₃, H₂O, NO₂, aerosol extinction, and temperature. It covers a spectral range
25 from approximately 350 to 1060 nm in nine channels. The latest available version is Version 6 which covers the period October 1993 to November 1996. Measurements

**A new database of
trace gases and
aerosols**

B. Hassler et al.

Title Page

Abstract

Introduction

Conclusions

References

Tables

Figures

◀

▶

◀

▶

Back

Close

Full Screen / Esc

Printer-friendly Version

Interactive Discussion



were made between 55° and 71° N and between 63° and 88° S with a vertical resolution of ~1 km. The profiles of the different measured species cover an altitude range from 10 km to 50 km (see Table 3). For a more detailed description of the POAM II instrument and the retrievals see [Glaccum et al. \(1996\)](#) and [Lumpe et al. \(1997\)](#), respectively.

5 POAM III was launched after the satellite on which POAM II was located failed. It started measurements in April 1998 and ended in November 2005. Version 4 is the latest available dataset for POAM III. In this version, quality flags for the profiles of O₃, H₂O and NO₂ were included to allow screening of lower quality measurements resulting from sunspot activity and aerosol artifacts ([Lumpe et al., 2006](#)). Beside these additions,
10 POAM III data sets contain the same species as POAM II, with the measuring channels for the aerosol extinctions slightly shifted (see Table 1). The vertical resolution is also ~1 km ([Randall et al., 2003](#)), and the measurements were made in almost identical latitude bands (from 54°–71° N and 62°–88° S). The altitude range is slightly bigger for POAM III than for POAM II (see Table 3). For a more detailed description of the
15 POAM III instrument and its retrieval algorithms see [Lucke et al. \(1999\)](#) and [Lumpe et al. \(2002\)](#), respectively.

Since temperature and pressure are not directly measured with the POAM instruments, both variables are taken from reanalyses either from the UK Met Office (UKMO) or the National Centers for Environmental Prediction (NCEP) and are included in the database. For sorting POAM II and POAM III in Grid II (latitude/pressure) and Grid III (equivalent latitude/potential temperature), the pressure and temperature values from NCEP were used. A sunrise/sunset identifier is also included in each measurement set. Error values are available for both POAM II and POAM III from the original data files and could therefore be added to the database.

A new database of trace gases and aerosols

B. Hassler et al.

[Title Page](#)[Abstract](#)[Introduction](#)[Conclusions](#)[References](#)[Tables](#)[Figures](#)[I◀](#)[▶I](#)[◀](#)[▶](#)[Back](#)[Close](#)[Full Screen / Esc](#)[Printer-friendly Version](#)[Interactive Discussion](#)

3.4 Ozonesonde data

3.4.1 Ozonesonde data selection

Ozonesondes are balloon-borne instruments that measure in situ ozone with a wet-chemical method: ambient air is pumped through an electrolytic cell containing a buffered potassium iodide solution where ozone oxidizes the iodide into iodine. The resultant current within the cell is directly proportional to the ozone concentration in the cell. There are several different ozonesonde types in use globally, with the most common being the electrochemical concentration cell (ECC) (Komhyr, 1969), the Brewer-Mast (BM) bubbler (Brewer and Milford, 1960) and the carbon-iodine (CI) sonde (Komhyr, 1965). All ozonesondes are flown together with a radiosonde to measure pressure, temperature and relative humidity.

Many studies analysing the suitability of ozonesonde measurements for long-term ozone trend detection have been published (Tiao et al., 1986; Bodeker et al., 1998; Logan et al., 1999). Although the quality of the ozonesonde data depends on the sonde preparation, the experience of the measuring team and some sources of error particular to each instrument, the measurement uncertainties are generally small and can be quantified. The ozonesonde measurements are also the only data included in this version of the BDBP that provide coverage in the troposphere. The ozonesonde data were subjected to thorough quality checks (described below) before being added to the BDBP.

Seven different sources for ozonesonde data were used for the database:

1. WOUDC Data DVD “Ozone Data for the world, ODW DVD#1, 1926–2005”,
2. WOUDC database webpage for the most recent data not provided on the DVD (http://www.woudc.org/data_e.html),
3. NOAA webpage, mainly for data from US stations (<ftp://ftp.cmdl.noaa.gov/ozwv/ozone/>),
4. NDACC webpage, for stations that submit data only to the NDACC or for stations

A new database of trace gases and aerosols

B. Hassler et al.

Title Page

Abstract

Introduction

Conclusions

References

Tables

Figures

◀

▶

◀

▶

Back

Close

Full Screen / Esc

Printer-friendly Version

Interactive Discussion



**A new database of
trace gases and
aerosols**B. Hassler et al.

Title Page

Abstract

Introduction

Conclusions

References

Tables

Figures

◀

▶

◀

▶

Back

Close

Full Screen / Esc

Printer-friendly Version

Interactive Discussion



that submit data to both but in a more timely fashion to the NDACC (<http://www.ndsc.ncep.noaa.gov/data/>).

- 5 5. SHADOZ webpage, for equatorial stations not submitting their data to the WOUDC (<http://croc.gsfc.nasa.gov/shadoz/>).
6. Directly from the Lauder archive of ozonesonde flights,
7. Private communications with H. Claude from Hohenpeissenberg and R. Kivi from Sodankyla to get source profiles from those stations.

In total, profiles from 136 stations were added to the BDBP spanning 82° N to 90° S (see Table A1). As long as the sonde type was detailed in the original data file, that sounding was rated as a potential candidate to be added to the database after passing several quality checks which are described below. Soundings from the following sonde types were accepted: Brewer-Mast, Brewer-GDR ([Ronnebeck and Sonntag, 1976](#)), ECC, Carbon-Iodine, Indian ([Shreedharan, 1968](#)) and Regener. Where the altitude and/or time after launch was not available in the original data file, or when the values were unrealistic (e.g. a time after launch of 3 h for the first data level), these were (re)calculated from the pressure and temperature measurements assuming a mean ascent rate of 6 m/s.

Normalization factors (NFs) are calculated by dividing a total column ozone value derived from the ozonesonde ozone profile by an independent total column ozone measurement available either from a coincident ground-based (Dobson or Brewer spectrophotometer) or satellite-based column ozone measurement. For the ozonesonde flights added to the BDBP, new NFs were calculated as follow. First the ozone column from the surface to the top of the ozonesonde flight was calculated using trapezoidal integration. Then the missing ozone between the top of the flight and the top of the atmosphere was added using the climatology of [McPeters et al. \(2007\)](#). Added together these provide the total column ozone estimate from the ozonesonde flight. The independent total column ozone value was extracted from the NIWA combined total column ozone database ([Müller et al., 2007](#)) according to the date, time and location of the ozonesonde flight. Because this combined total column ozone database is avail-

able only from November 1978 onwards, new NFs could not be calculated for flights prior to that date. For flights not reaching 30 hPa the uncertainty on the partial column above the top of the flight is large and a reliable new NF could not be calculated. Therefore flights not reaching 30 hPa were rejected. Both the original NFs listed in the data files (if available), and the new NFs, are considered for quality checks. If both NFs are available, the original NF must be between 0.9 and 1.1 and the new NF must be between 0.8 and 1.2. If only one NF is available then only the check appropriate for that NF is performed. If neither NF is available the profile is not added to the BDBP.

Each ozonesonde measurement set includes the original NF, or the new NF if the original is not available, so that users of the ozonesonde data in the BDBP can choose whether or not to apply the NF to the ozone measurements. While the NF is stored in the BDBP it was not applied to the ozonesonde data.

Since the measurements in the BDBP are stored at specific altitude/pressure/theta levels, the values for those levels extracted from the ozonesonde profiles must be interpolated. For an interpolated value to be added to the database at least one measurement must be within 200 m of the respective level.

The period for which data are available differs from station to station. Flights started in the early 1960s at a few stations distributed globally. At many stations flights were done just for a few years, while other stations have measurements only during some months or during campaigns, and some stations have a continuous time series of ozone profiles up until the present. In the late 1990s, new ozonesonde stations were chosen to cover regions poorly represented at that time, specifically over the equator and Southern Hemisphere (Thompson et al., 2003). Combining all 7 mentioned ozonesonde data sources, flights from the early 1960s to 2006 were added to the BDBP as long as profiles were available and of suitable quality.

3.4.2 Ozonesonde data errors

The ozonesonde data files obtained through the sources detailed above for the most part do not include the measurement errors associated with each measurement, nei-

A new database of trace gases and aerosols

B. Hassler et al.

Title Page

Abstract

Introduction

Conclusions

References

Tables

Figures

◀

▶

◀

▶

Back

Close

Full Screen / Esc

Printer-friendly Version

Interactive Discussion



ther for ozone, temperature, relative humidity nor pressure. To estimate the error on the ozone measurement, information about sonde type quality and measurement errors were obtained from [Smit and Kley \(1996\)](#) unless otherwise specified (see below). According to their suggested classification of sonde type and altitude range different ozone error values were applied (see Fig. 2). In addition:

- ECC ozonesondes: error values were taken from [Komhyr et al. \(1985\)](#). For Lauder the error profiles for ECC ozonesondes of the 4A and 5A series described by [Bodeker et al. \(1998\)](#) were applied.
- Regener ozonesondes: those sondes were not tested in the analysis of [Smit and Kley \(1996\)](#), but it is known that the errors of those sondes tend to be quite high ([WMO, 1989](#)), so relatively high error values, commensurate with other ozonesonde types with high errors, were assumed.

Error values for temperature, pressure and relative humidity for the soundings were set as follows:

- Temperature: error values for the sonde temperature measurements are set according to [Bodeker et al. \(1998\)](#). Different error values for unshaded and shaded temperature sensors are prescribed. For most soundings information about the shading of the temperature sensor is not available (the exception being Lauder) so error values for unshaded sensors are used.
- Pressure: depending on the station, different pressure error values are assumed. Since more detailed information about the soundings at Lauder are available, the pressure error value for that station was calculated from a large data set of calibrated pressure sensors and found to be 0.258 hPa. For all other stations error values were assumed to be ~1 hPa up to a height of 100 hPa, and ~0.5 hPa from a measurement height higher than 100 hPa, according to personal communication with Vaisala about pressure errors for radiosonde measurements.
- Relative humidity: for all stations and all altitudes an error value of 3% for the relative humidity measurement was assumed, according to personal communication

**A new database of
trace gases and
aerosols**

B. Hassler et al.

Title Page

Abstract

Introduction

Conclusions

References

Tables

Figures



Back

Close

Full Screen / Esc

Printer-friendly Version

Interactive Discussion



with Vaisala about humidity errors for radiosonde measurements.

It is not always Vaisala radiosondes that are flown with each ozonesonde at every station and the type of radiosonde used is seldom logged in the original ozonesonde data files. However, since Vaisala radiosondes are the most commonly used sondes, for all sonde data added to the BDBP the error values for pressure and relative humidity are set to the Vaisala radiosonde errors.

3.4.3 Quality check

In addition to the error checks described above, several further checks were made to screen and remove poor quality data from the ozonesonde data files, viz.:

- Individual ozone records are rejected when negative ozone partial pressures, 0.0 mPa ozone partial pressures within 60° of the equator, or ozone partial pressure ≥ 25 mPa at altitudes above 30 hPa are measured.
- Entire ozone profiles are rejected when unrealistically low ozone values over the whole profile (profile mean < 2 mPa and profile maximum < 4 mPa) are found or when more than 33% of all ozone values in the profile are 0.0 mPa.
- Individual temperature records are rejected when values in the troposphere $> 60^\circ\text{C}$ or in the case of extreme spikes in stratospheric temperature (for one or two consecutive values). The spikes were defined in two different ways according to the resolution of the checked profile. Profiles with more than 10 values per kilometre were categorised as “high-resolution” profiles. For those the mean temperature and standard deviation for every km-layer was calculated and data values were rejected if they exceeded the range of mean temperature ± 30 standard deviations. Temperature spikes for “low-resolution” profiles were defined by exceeding a maximum lapse rate. In the troposphere data values were rejected if the lapse rate was higher than 0.06 K/m, for the stratosphere the maximum lapse rate was lowered slightly to 0.04 K/m.

A new database of trace gases and aerosols

B. Hassler et al.

Title Page

Abstract

Introduction

Conclusions

References

Tables

Figures

◀

▶

◀

▶

Back

Close

Full Screen / Esc

Printer-friendly Version

Interactive Discussion



- When two identical records at the same pressure/altitude level (not defined as ascending and descending values) are found, one is rejected.

No relative humidity values above the tropopause (as assumed for the application of the error values – see above) were added to the database since errors in humidity measurements from radiosondes are known to increase with decreasing water vapour content, temperature and pressure (Elliott and Gaffen, 1991). Stratospheric humidity data from radiosondes are therefore thought to be of no big use (SPARC, 2000). Although Miloshevich et al. (2001) worked out a correction for relative humidity measurements for Vaisala RS80-A radiosondes, no further quality improvements were performed to the sonde humidity data in the database since in most cases the radiosonde type was not known.

4 Database temporal, latitudinal and longitudinal coverage

By combining measurements from several satellite-based instruments and from ozonesondes it is possible to achieve high temporal and spatial coverage in the BDBP. Table 2 summarizes the temporal coverage of the satellites and these, together with the ozonesondes, are shown graphically in Fig. 3. Note that although the ozonesonde data cover a long time period, the spatial coverage can be poor due to the number and location of the ozonesonde stations. In this version of the BDBP, for 2006, only ozonesonde data are available, and so the spatial coverage for 2006 is poorer than for the preceding years.

To quantify the spatial and temporal coverage of the BDBP for a given altitude-/pressure/isentropic level, we have defined factors (hereafter referred to as B-factors) that combine the temporal and spatial coverage into one value. For a given level, a spatial grid is selected (e.g. 2° latitude by 5° longitude) and monthly means within each grid cell are calculated (described further in Sect. 5) over some selected time period. A B-factor of N% means that at least N% of the grid cells have a monthly mean for at

A new database of trace gases and aerosols

B. Hassler et al.

Title Page

Abstract

Introduction

Conclusions

References

Tables

Figures

◀

▶

◀

▶

Back

Close

Full Screen / Esc

Printer-friendly Version

Interactive Discussion



least N% of the months in the selected time period. The B-Factor does not indicate which part of the globe is not sampled nor which periods within the total period are not covered. Figure 4 shows B-factors for a resolution of 2° latitude by 5° longitude for O₃ as a function of changing time period (panel a) and changing data source (panel b) as well as NO₂ and H₂O for changing time period (panels c and d, respectively).

As mentioned earlier, one selection criteria for the BDBP data sources was the goal of high temporal and spatial coverage for ozone and temperature. It can be seen in Fig. 4 that ozone has the highest B-factors for all three shown species, exceeding 80% between ~10 km and ~30 km even at a high resolution of 2° by 5°. For O₃, the periods with a late start year have higher B-factors as a result of sparser coverage early in the period (see Fig. 3). B-factors for temperature are even slightly higher than those for O₃ but are not shown here. Above 60 km coverage of ozone decreases rapidly.

In panel (b) of Fig. 4 the effects of the cumulative addition of different data sources on the temporal and spatial coverage of the BDBP are shown. First the effects of adding SAGE II data are shown, followed, in order, by SAGE I, HALOE, POAM II, POAM III and finally ozonesondes. Even though the addition of POAM III data extends the temporal coverage of the BDBP, the B-factors do not change with the addition of the POAM III data because it does not extend the spatial coverage. Clearly, at a resolution of 2° by 5°, the inclusion of the ozonesondes is vital to achieve B-factors above 80% in the stratosphere and any coverage at all in the lower troposphere.

NO₂ coverage does not reach the 80% mark although it is close in the altitude range ~15 km to ~45 km (see Fig. 4c). Only very sparse data are available at altitude levels above ~45 km and below ~15 km.

Of the 3 species shown, H₂O is the only one with almost constant B-factors throughout the stratosphere and lower mesosphere (Fig. 4d), from ~15 km up to 70 km. While relative humidity from the ozonesonde flights is added to the BDBP in the troposphere, these measurements are excluded from panel (d) of Fig. 4 since only water vapour measurements are considered. However, B-factors are significantly lower (maximum at around 40%) than for the other species caused by the low number of satellite instru-

**A new database of
trace gases and
aerosols**B. Hassler et al.

[Title Page](#)[Abstract](#)[Introduction](#)[Conclusions](#)[References](#)[Tables](#)[Figures](#)[⏪](#)[⏩](#)[◀](#)[▶](#)[Back](#)[Close](#)[Full Screen / Esc](#)[Printer-friendly Version](#)[Interactive Discussion](#)

ments that were added to the BDBP providing H₂O data (see Table 3).

5 Comparison with Randel and Wu database

An often used and well established database for ozone trend analyses and calculations of changes in radiative forcing by ozone is that from [Randel and Wu \(2007\)](#), hereafter referred to as R&W. In this section, monthly means of ozone at selected altitudes and latitudes calculated from the BDBP are compared with R&W. As mentioned in Sect. 1, R&W consists of monthly mean zonal mean ozone and is based mainly on SAGE I and SAGE II data, with ozonesonde profiles from Syowa and Resolute providing high latitude coverage.

Figure 5 compares monthly mean times series from the BDBP and R&W at the equator and 25 km altitude. The monthly means for the BDBP and for SAGE I+SAGE II were calculated over the same latitude band as in R&W, but with the requirement that there had to be at least 6 values available at the given latitude and altitude for the monthly mean to be valid. For both the BDBP and SAGE I+SAGE II, of the individual values available for the calculation of the monthly means, the highest and lowest 25% were discarded to ensure that extreme values were not included. This rather simple method of rejecting extreme values is sufficient for this exercise; more sophisticated methods are in development for a 3-D (latitude, altitude, time) monthly mean ozone database that will be created from the BDBP.

Even though R&W are based on SAGE I and SAGE II only in this part of the atmosphere, there are no missing values since the values provided by R&W are not the raw monthly means, but the values from a regression model fit to the raw monthly means (W. Randel personal communication). Also apparent in panel (a) of Fig. 5 is an offset between BDBP and R&W with BDBP monthly means being higher. The source of this offset is highlighted in panel (b); R&W add monthly mean anomalies to the climatology of [Fortuin and Kelder \(1998\)](#) whereas the BDBP simply provides the original means of the raw data. If the anomaly time series alone are compared (Fig. 5c) it is clear that the

A new database of trace gases and aerosols

B. Hassler et al.

Title Page

Abstract

Introduction

Conclusions

References

Tables

Figures

◀

▶

◀

▶

Back

Close

Full Screen / Esc

Printer-friendly Version

Interactive Discussion



agreement between the BDBP and R&W is excellent. It is also clear that R&W does not capture some of the outliers in the BDBP (e.g. November 1984) because R&W is the regression model fit and not the raw monthly mean data.

Figure 6 shows another comparison between the BDBP and R&W where ozone anomalies were calculated by subtracting the mean annual cycle from monthly mean time series, for altitudes between 1 km and 70 km and for the latitude zone from 40° N to 50° N.

The mean annual cycles (right hand panels in Fig. 6) compare well. The BDBP covers a greater altitude range than R&W providing data between 50 and 70 km and, more importantly, good coverage in the troposphere. With a latitude band of 10° the number of missing monthly means calculated using the BDBP is small; the gap in the earlier 1980s above ~33 km is between SAGE I and SAGE II (ozonesondes provide data at lower altitudes). Anomalies (left hand panels in Fig. 6) of the same sign are found during similar periods and at similar altitudes. However, the BDBP anomalies have greater vertical scale, extending down to ~10 km altitude whereas those of R&W are suppressed below 20 km. The anomalies calculated using the BDBP show greater temporal variability and larger amplitudes than R&W. This is because R&W is based on regression model output and regression models cannot capture all of the variability. Because the regression model used by R&W does not include a basis function to describe the effects of volcanic eruptions on ozone, negative ozone anomalies in the lower stratosphere related to the Pinatubo eruption in the early 1990s are significantly more apparent in the BDBP than in R&W. There is a discontinuity in the BDBP anomalies at ~5 km altitude. This is an artifact of the monthly mean calculations using the BDBP where satellite data are not available for the monthly means at one altitude but are at the next higher altitude. Data from all of the added satellite instruments (see Sect. 3) have large error values in the troposphere for all measured species due to the tropospheric aerosol loading. It is suggested in various studies not to use these data for quantitative analyses (see for example Kar et al., 2002). For the purposes of this preliminary comparison with R&W, the approach used to calculate the monthly means

A new database of trace gases and aerosols

B. Hassler et al.

Title Page

Abstract

Introduction

Conclusions

References

Tables

Figures

◀

▶

◀

▶

Back

Close

Full Screen / Esc

Printer-friendly Version

Interactive Discussion



is adequate. However, for a more accurate monthly mean database, weighting of the measurements used in each mean with their errors should be incorporated.

6 Summary and Outlook

The material presented above outlines the construction of a new global database of trace gases and aerosols from multiple sources of high vertical resolution measurements. The first version of this database, referred to as BDBP version 1.0, includes measurements from several solar occultation satellite instruments (SAGE I and II, POAM II and III, HALOE) and from ozonesonde flights from over 130 stations globally, covering the period 1962 to 2006. It is planned to update the database annually to include the newest ozonesonde data, add historical data sources that have not yet been included (e.g. ILAS and GOMOS, and more ground-based measurements, for example lidar data), add measurements from new satellite-based instruments currently in development, and possibly newer versions of the data already in the database (e.g. from the application of improved satellite retrieval algorithms).

The internal construction of the database allows for considerable flexibility:

- Where measurements are available at high temporal resolution, e.g. during an intensive ozonesonde campaign, the resolution of the original data is maintained.
- Measurement sets can include any number of individual measurements taken by the same instrument at that latitude, longitude, altitude and time and this can vary between data sources or within a data source.
- The database has a single common format so that utilities to extract subsets of data from the BDBP are easy to write and quick to execute.
- The database consist of three different grids but the structure of the measurement sets is the same for all three grids which simplifies data handling.
- The construction of the database allows for new, as yet undefined, species, or measurements from new instruments, to be added without revision of the existing database – the measurement sets from the new instruments, possibly including newly defined species, are interleaved amongst the existing measurement sets.

A new database of trace gases and aerosols

B. Hassler et al.

Title Page

Abstract

Introduction

Conclusions

References

Tables

Figures

◀

▶

◀

▶

Back

Close

Full Screen / Esc

Printer-friendly Version

Interactive Discussion



- Measurement sets for a latitude and altitude are sorted by time which speeds up navigation and searching within the BDBP.
- Although the original trace gas profiles are not included in the BDBP as one coherent unit but are stored on pre-defined levels, profiles can easily be extracted from the BDBP, if required, since the vertical resolution is high (about 1 km for Grid I and Grid II).

This flexibility allows for multiple applications:

- Because temporal means are not calculated, trace gas profiles at a specific location and time, if available, can be extracted for studies requiring point source data.
- Case studies with data from only one data source, or a combination of data sources, can be made.
- Since a longitude value is stored with each measurement set, analyses requiring longitudinal disaggregation can be undertaken.
- The temporal and spatial coverage of the BDBP is sufficient to provide data for statistically significant trend analyses.
- It is possible to bin the data from the BDBP in several different spatial and temporal resolutions, as required for analyses (e.g. monthly means, seasonal means, yearly means, etc.), since data in the BDBP are stored with the information of the exact measurement time, latitude and longitude.
- The combination of data sources in the BDBP provides a robust basis for climatology calculations which can be used to validate chemistry-climate models.
- Since the BDBP covers a long time period, climatologies calculated from the BDBP can be used to provide boundary conditions for model simulations.

A new database of trace gases and aerosols

B. Hassler et al.

Title Page

Abstract

Introduction

Conclusions

References

Tables

Figures

◀

▶

◀

▶

Back

Close

Full Screen / Esc

Printer-friendly Version

Interactive Discussion



Examples of some of the products available through the BDBP are shown in Fig. 7.

The evolution of the ozone hole every spring is clearly visible and the values from the 6 different data sources show no significant offsets or drifts in comparison to each other. The NO₂ time series plotted in panel (b) of Fig. 7 shows decreases in NO₂ in 1991 and 1992 resulting from the Mt. Pinatubo eruption. The H₂O time series plotted in panel (c) of Fig. 7 shows good agreement between the HALOE and SAGE II data sources and the derived monthly means are in good agreement with Fig. 3a of Rosenlof et al. (2001). In contrast to the high water vapour values seen in the 1991-1994 SAGE II data in Fig. 3a of Rosenlof et al. (2001), the SAGE II data screening implemented here removes most of the H₂O data points in this period where measurements were strongly affected by the eruption of Mt. Pinatubo.

This version of the BDBP does not consider problems of inhomogeneities between the different data sources. While comprehensive screening was applied to the different data sources, systematic offsets and drifts between the data sources are likely. Applications using the BDBP, e.g. the calculation of a monthly mean 3-D ozone database, will need to consider removal of these offsets and drifts.

An advantage of combining measurements from multiple sources is the improved temporal and spatial coverage achieved. It was shown that only with the combination of the different data sources a high index of coverage (B-factor) could be achieved. Especially the ozonesonde data contribute considerably to the coverage of the troposphere and the lower stratosphere.

One of the first applications of the BDBP will be the creation of a global latitude/altitude/time monthly mean ozone database to provide the ozone boundary conditions for global climate model simulations. To achieve this, missing values need to be spatially and/or temporally interpolated and is the focus of ongoing development.

Acknowledgements. We thank all institutions and colleagues who provided us with data for the database: NASA, NRL, WOUDC, NOAA, NDACC, SHADOZ, H. Claude, R. Kivi, L. W. Thomason and all the people involved in the measurements and processing of the data. We also want to thank R. Schofield for the valuable advice on the SAGE II data screening details,

A new database of trace gases and aerosols

B. Hassler et al.

Title Page

Abstract

Introduction

Conclusions

References

Tables

Figures

◀

▶

◀

▶

Back

Close

Full Screen / Esc

Printer-friendly Version

Interactive Discussion



L. W. Thomason for the suggestions about the SAGE I data screening method, W. J. Randel and F. Wu for access to their database, as well as W. J. Randel for answering patiently all our questions concerning the R&W database. B. Hassler's work was funded by a DAAD studentship.

5 References

- Bhatt, P. P., Remsberg, E. E., Gordley, L. L., McInerney, J. M., Brackett, V. G., and Russell III, J. M.: An evaluation of the quality of Halogen Occultation Experiment ozone profiles in the lower stratosphere, *J. Geophys. Res.*, 104(D8), 9261–9275, 1999. [7667](#)
- Bodeker, G. E., Boyd, I. S., and Matthews, W. A.: Trends and variability in vertical ozone and temperature profiles measured by ozonesondes at Lauder, New Zealand: 1986–1996, *J. Geophys. Res.*, 103(D22), 28 661–28 681, 1998. [7669](#), [7672](#)
- Brewer, A. W. and Milford, J. R.: The Oxford-Kew Ozone sonde, *Proc. R. Soc. London A*, 256, 470–495, 1960. [7669](#)
- Butchart, N. and Remsberg, E. E.: The area of the stratospheric polar vortex as a diagnostic for tracer transport on an isentropic surface, *J. Atmos. Sci.*, 43, 1319–1339, 1986. [7660](#)
- Cunnold, D. M., Chu, W. P., Barnes, R. A., McCormick, M. P., and Veiga, R. E.: Validation of SAGE II Ozone Measurements, *J. Geophys. Res.*, 94(D6), 8447–8460, 1989. [7663](#)
- Elliott, W. P. and Gaffen, D. J.: On the utility of radiosonde humidity archives for climate studies, *B. Am. Meteorol. Soc.*, 72, 1507–1520, 1991. [7674](#)
- Forster, P. M. d. F. and Shine, K. P.: Radiative forcing and temperature trends from stratospheric ozone changes, *J. Geophys. Res.*, 102, 10 841–10 855, 1997. [7659](#)
- Fortuin, J. P. and Kelder, H.: An ozone climatology based on ozonesonde and satellite measurements, *J. Geophys. Res.*, 103(D24), 31 709–31 734, 1998. [7659](#), [7676](#)
- Glaccum, W., Lucke, R., Bevilacqua, R. M., Shettle, E. P., Hornstein, J. S., Chen, D. T., Lumpe, J. D., Krigman, S. S., Debrestian, D. J., Fromm, M. D., Dalaudier, F., Chassefiere, E., Deniel, C., Randall, C. E., Rusch, D. W., Olivero, J. J., Brogniez, C., Lenoble, J., and Kremer, R.: The Polar Ozone and Aerosol Measurement (POAM II) Instrument, *J. Geophys. Res.*, 101(D9), 14 479–14 487, 1996. [7668](#)
- Hervig, M. and McHugh, M.: Cirrus detection using HALOE measurements, *Geophys. Res. Lett.*, 26(6), 719–722, 1999. [7667](#)

ACPD

8, 7657–7702, 2008

A new database of trace gases and aerosols

B. Hassler et al.

Title Page

Abstract

Introduction

Conclusions

References

Tables

Figures

◀

▶

◀

▶

Back

Close

Full Screen / Esc

Printer-friendly Version

Interactive Discussion



**A new database of
trace gases and
aerosols**B. Hassler et al.

Title Page

Abstract

Introduction

Conclusions

References

Tables

Figures

◀

▶

◀

▶

Back

Close

Full Screen / Esc

Printer-friendly Version

Interactive Discussion

- Kar, J., Treppe, C. R., Thomason, L. W., Zawodny, J. M., Cunnold, D. M., and Wang, H.-J.: On the tropospheric measurements of ozone by the Stratospheric Aerosol and Gas Experiment II (SAGE II, version 6.1) in the tropics, *Geophys. Res. Lett.*, 29(24), 2208, doi:10.1029/2002GL016241, 2002. [7677](#)
- 5 Kistler, R., Kalnay, E., Collins, W., Saha, S., White, G., Woollen, J., Chelliah, M., Ebisuzaki, W., Kanamitsu, M., Kousky, V., van den Dool, H., Jenne, R., and Fiorino, M.: The NCEPNCAR 50Year Reanalysis: Monthly Means CDROM and Documentation, *B. Am. Soc.*, 82(2), 247–267, 2001. [7661](#)
- Komhyr, W. D.: A carbon-iodine sonde sensor for atmospheric soundings, *Proc. Ozone Symp.*,
10 Albuquerque, p. 26, Geneva, 1965. [7669](#)
- Komhyr, W. D.: Electrochemical concentration cells for gas analysis, *Ann. Geophys.*, 25, 2003–210, 1969, <http://www.ann-geophys.net/25/2003/1969/>. [7669](#)
- Komhyr, W. D., Oltmans, S. J., Chopra, A. N., and Franchois, P. R.: Performance characteristics of high-altitude ECC ozonsondes, in: *Atmospheric Ozone, Proceedings of the Quadrennial Ozone Symposium, Greece, 1985*. [7672](#), [7696](#)
- 15 Liu, X., Chance, K., Sioris, C. E., Kurosu, T. P., and Newchurch, M. J.: Intercomparison of GOME, ozonesonde, and SAGE II measurements of ozone: Demonstration of the need to homogenize available ozonesonde data sets, *J. Geophys. Res.*, 111, D14305, doi:10.1029/2005JD006718, 2006. [7663](#)
- 20 Logan, J. A., Megretskaia, I. A., Miller, A. J., Tiao, G. C., Choi, D., Zhang, L., Stolarski, R. S., Labow, G. J., Hollandsworth, S. M., Bodeker, G. E., Claude, H., DeMuer, D., Kerr, J. B., Tarasick, D. W., Oltmans, S. J., Johnson, B., Schmidlin, F., Staehelin, J., Viatte, P., and Uchino, O.: Trends in the vertical distribution of ozone: a comparison of two analyses of ozonesonde data, *J. Geophys. Res.*, 104, 26 373–26 399, 1999. [7669](#)
- 25 Lucke, R. L., Korwan, D., Bevilacqua, R. M., Hornstein, J. S., Shettle, E. P., Chen, D. T., Daehler, M., Lumpe, J. D., Fromm, M. D., Debrestian, D., Neff, B., Squire, M., König-Langlo, G., and Davies, J.: The Polar Ozone and Aerosol Measurement (POAM III) Instrument and Early Validation Results, *J. Geophys. Res.*, 104(D15), 18 785–18 799, 1999. [7668](#)
- Lumpe, J. D., Bevilacqua, R. M., Hoppel, K. W., Krigman, S. S., Kriebel, D. L., Randall, C. E., Rusch, D. W., Brogniez, C., Ramanananaherosa, R., Shettle, E. P., Olivero, J. J., Lenoble, J., and Pruvost, P.: POAM II Retrieval Algorithm and Error Analysis, *J. Geophys. Res.*, 102(D19), 23 593–23 614, 1997. [7668](#)
- 30 Lumpe, J. D., Bevilacqua, R. M., Hoppel, K. W., and Randall, C. E.: POAM III Retrieval Algo-

rithm and Error Analysis, *J. Geophys. Res.*, 107(D21), 4575, doi:10.1029/2002JD002137, 2002. [7668](#)

Lumpe, J., Bevilacqua, R., Randall, C., Nedoluha, G., Hoppel, K., Russel, J., Harvey, V. L., Schiller, C., Sen, B., Taha, G., Toon, G., and Vömel, H.: Validation of Polar Ozone and Aerosol Measurement (POAM) III version 4 stratospheric water vapor, *J. Geophys. Res.*, 111, D11301, doi:10.1029/2005JD006763, 2006. [7668](#)

McCormick, M. P., Zawodny, J. M., Veiga, R. E., Larsen, J. C., and Wang, P. H.: An overview of SAGE I and SAGE II ozone measurements, *Planet. Space Sci.*, 37(12), 1567–1586, 1989. [7663](#)

McKenna, D. S., Groöb, J.-U., Günther, G., Konopka, P., Müller, R., Carver, G., and Sasano, Y.: A new Chemical Lagrangian Model of the Stratosphere (CLaMS) 2. Formulation of chemistry scheme and initialization, *J. Geophys. Res.*, 107, 4256, 10.1029/2000JD000113, 2002. [7667](#)

McPeters, R. D., Lebow, G. J., and Logan, J. A.: Ozone climatological profiles for satellite retrieval algorithms, *J. Geophys. Res.*, 112, D05308, doi:10.1029/2005JD006823, 2007. [7670](#)

Miloshevich, L. M., Vömel, H., Paukkunen, A., Heymsfield, A. J., and Oltmans, S. J.: Characterization and correction of relative humidity measurements from Vaisala RS80-A radiosondes at cold temperatures, *J. Atmos. Ocean. Tech.*, 18, 135–156, 2001. [7674](#)

Müller, R., Groöb, J.-U., Lemmen, K., Heinze, D., Dameris, M., and Bodeker, G. E.: Simple measures of ozone depletion in the polar stratosphere, *Atmos. Chem. Phys.*, 8, 251–264, 2008, <http://www.atmos-chem-phys.net/8/251/2008/>. [7670](#)

Nash, E. R., Newman, P. A., Rosenfield, J. ., and Schoeberl, M. R.: An objective determination of the polar vortex using Ertel's potential vorticity, *J. Geophys. Res.*, 101(D5), 9471–9478, 1996. [7661](#)

Nazaryan, H. and McCormick, M. P.: Comparisons of Stratospheric Aerosol and Gas Experiment (SAGE II) and Solar Backscatter Ultraviolet Instrument (SBUV/2) ozone profiles and trend estimates, *J. Geophys. Res.*, 110, D17302, doi:10.1029/2004JD005483, 2005. [7663](#)

Randall, C. E., Rusch, D. W., Bevilacqua, R. M., Hoppel, K. W., Lumpe, J. D., Shettle, E., Thompson, E., Deaver, L., Zawodny, J., Kyrö, E., Johnson, B., Kelder, H., Dorokhov, V. M., König-Langlo, G., and Gil, M.: Validation of POAM III ozone: Comparisons with ozonesonde and satellite data, *J. Geophys. Res.*, 108(D12), 4367, doi:10.1029/2002JD002944, 2003. [7668](#)

Randel, W. J. and Wu, F.: A stratospheric ozone profile data set for 1979-2005: Variability, trends, and comparisons with column ozone data, *J. Geophys. Res.*, 112, D06313,

A new database of trace gases and aerosols

B. Hassler et al.

Title Page

Abstract

Introduction

Conclusions

References

Tables

Figures

◀

▶

◀

▶

Back

Close

Full Screen / Esc

Printer-friendly Version

Interactive Discussion



**A new database of
trace gases and
aerosols**

B. Hassler et al.

Title Page

Abstract

Introduction

Conclusions

References

Tables

Figures

◀

▶

◀

▶

Back

Close

Full Screen / Esc

Printer-friendly Version

Interactive Discussion

doi:10.1029/2006JD007339, 2007. [7659](#), [7660](#), [7676](#)

Remsberg, E. E. and Deaver, L. E.: Interannual, solar cycle, and trend terms in middle atmospheric temperature time series from HALOE, *J. Geophys. Res.*, 110, D06106, doi:10.1029/2004JD004905, 2005. [7667](#)

5 Rind, D., Lerner, J., and Zawodny, J.: A complementary analysis for SAGE II data profiles, *Geophys. Res. Lett.*, 32, L07812, doi:10.1029/2005GL022550, 2005. [7665](#)

Ronnebeck, K. and Sonntag, D.: Eine weiterentwickelte elektrochemische Ozonradsosonde, *Z. Meteorol.*, 26, 15–19, 1976. [7670](#)

10 Rosenlof, K. H., Oltmans, S. J., Kley, D., Russell, J. M. III, Chiou, E.-W., Chu, W. P., Johnson, D. G., Kelly, K. K., Michelsen, H. A., Nedoluha, G. E., Remsberg, E. E., Toon, G. C., and McCormick, M. P.: Stratospheric water vapour increases over the past half-century, *Geophys. Res. Lett.*, 28(7), 1195–1198, 2001. [7680](#)

Russell, J. M. III, Gordley, L. L., Park, J. H., Drayson, S. R., Hesketh, D. H., Cicerone, R. J., Tuck, A. F., Frederick, J. E., Harries, J. E., and Crutzen, P.: The Halogen Occultation Experiment, *J. Geophys. Res.*, 98(D6), 10777–10797, 1993. [7667](#)

15 Shreedharan, C. R.: An Indian electrochemical ozonesonde, *J. Phys. E. Sci. Instrum.*, Sr-2, 995–997, 1968. [7670](#)

Smit, H. G. J. and Kley, D.: Jülich Ozone Sonde Intercomparison Experiment (JOSIE), 5 February–8 March 1996, WMO Report No. 130, 108 pp., 1996. [7672](#), [7696](#)

20 SPARC: Assessment of Upper Tropospheric and Stratospheric Water Vapour, Chap. 2, World Climate Research Programme, WCRP-113, WMP/TD-No.1043, 261–264, 2000. [7674](#)

Steil, B., Brühl, C., Manzini, E., Crutzen, P. J., Lelieveld, J., Rasch, P. J., Roeckner, E., and Krüger, K.: A new interactive chemistry-climate model: 1. Present-day climatology and inter-annual variability of the middle atmosphere using the model and 9 years of HALOE/UARS data, *J. Geophys. Res.*, 109(D9), 4290, doi:10.1029/2002JD002971, 2003. [7667](#)

25 Thompson, A. M., Witte, J. C., McPeters, R. D., Oltmans, S. J., Schmidlin, J. A., Logan, J. A., Fujiwara, M., Kirchhoff, V. W. J. H., Posny, F., Coetzee, G. J. R., Hoegger, B., Kawakami, S., Ogawa, T., Johnson, B. J., Vömel, H., and Labow, G.: Southern Hemisphere Additional Ozonesondes (SHADOZ) 1998–2000 tropical ozone climatology – 1. Comparison with Total Ozone Mapping Spectrometer (TOMS) and ground-based measurements, *J. Geophys. Res.*, 108(D2), 8238, doi:10.1029/2001JD000967, 2003. [7671](#)

30 Tiao, G. C., Reinsel, G. C., Pedrick, J. H., Allenby, G. M., Mateer, C. L., Miller, A. J., and DeLuisi, J. J.: A statistical trend analysis of ozonesonde data, *J. Geophys. Res.*, 91, 13 121–13 136,

1986. [7669](#)

Veiga, R. E., Cunnold, D. M., Chu, W. P., and McCormick, M. P.: Stratospheric aerosol and gas experiments I and II comparisons with ozonesondes, *J. Geophys. Res.*, 100(D5), 9073–9090, 1995. [7664](#)

5 Wang, H. J., Cunnold, D. M., and Bao, X.: A critical analysis of Stratospheric Aerosol and Gas Experiment ozone trends, *J. Geophys. Res.*, 101(D7), 12 495–12 514, 1996. [7664](#), [7665](#)

Wang, H. J., Cunnold, D. M., Thomason, L. W., Zawodny, J. M., and Bodeker, G. E.: Assessment of SAGE version 6.1 ozone data quality, *J. Geophys. Res.*, 107(D23), 4691, doi:10.1029/2002JD002418, 2002. [7663](#)

10 Wang, P.-H., Cunnold, D. M., Trepte, C. R., Wang, H. J., Jing, P., Fishman, J., Brackett, V. G., Zawodny, J. M., and Bodeker, G. E.: Ozone variability in the midlatitude upper troposphere and lower stratosphere diagnosed from a monthly SAGE II climatology relative to the tropopause, *J. Geophys. Res.*, 111, D21304, doi:10.1029/2005JD006108, 2006. [7663](#)

15 WMO (World Meteorological Organization): Scientific Assessment of Stratospheric Ozone: 1989, Vol. 1, Global Ozone Research and Monitoring Project - Report No. 50, 486 pp., Geneva, Switzerland, 1989. [7672](#)

ACPD

8, 7657–7702, 2008

**A new database of
trace gases and
aerosols**

B. Hassler et al.

Title Page

Abstract

Introduction

Conclusions

References

Tables

Figures

◀

▶

◀

▶

Back

Close

Full Screen / Esc

Printer-friendly Version

Interactive Discussion



Table 1. Variables stored in version 1.0 of the BDBP, together with their units and data source(s).

Species	Unit	Data sources
O ₃ number density	10 ¹⁸ molecules/m ³	SAGE I+II, POAM II+III, HALOE, ozonesondes
Temperature	K	SAGE I+II, POAM II+III, HALOE, ozonesondes
NO ₂ number density	10 ¹⁸ molecules/m ³	SAGE I+II, POAM II+III, HALOE
H ₂ O mixing ratio	10 ⁻⁶ moles/mole	SAGE II, POAM II+III, HALOE
NO mixing ratio	10 ⁻⁹ moles/mole	HALOE
CH ₄ mixing ratio	10 ⁻⁶ moles/mole	HALOE
HCl mixing ratio	10 ⁻⁹ moles/mole	HALOE
HF mixing ratio	10 ⁻⁹ moles/mole	HALOE
Relative humidity	%	ozonesondes
Aerosol extinction at 352.3 nm	1/km	POAM II
Aerosol extinction at 353.4 nm	1/km	POAM III
Aerosol extinction at 385 nm	1/km	SAGE II
Aerosol extinction at 441.6 nm	1/km	POAM II
Aerosol extinction at 442.3 nm	1/km	POAM III
Aerosol extinction at 450 nm	1/km	SAGE I
Aerosol extinction at 453 nm	1/km	SAGE II
Aerosol extinction at 525 nm	1/km	SAGE II
Aerosol extinction at 601.4 nm	1/km	POAM II
Aerosol extinction at 603.4 nm	1/km	POAM III
Aerosol extinction at 779.4 nm	1/km	POAM III
Aerosol extinction at 781 nm	1/km	POAM II
Aerosol extinction at 921 nm	1/km	POAM II
Aerosol extinction at 922.4 nm	1/km	POAM III
Aerosol extinction at 1000 nm	1/km	SAGE I
Aerosol extinction at 1018 nm	1/km	POAM III
Aerosol extinction at 1020 nm	1/km	SAGE II
Aerosol extinction at 1060 nm	1/km	POAM II
Aerosol surface area density	μm ² /cm ³	SAGE II
Aerosol effective radius	μm	SAGE II

A new database of trace gases and aerosols

B. Hassler et al.

Title Page

Abstract

Introduction

Conclusions

References

Tables

Figures

◀

▶

◀

▶

Back

Close

Full Screen / Esc

Printer-friendly Version

Interactive Discussion



A new database of trace gases and aerosols

B. Hassler et al.

Table 2. Coverage, vertical resolution, period spanned and source of the data for the satellite-based measurements included in version 1.0 of the BDBP.

Instrument	Latitudinal coverage	Vertical resolution	Period spanned	Data Source
HALOE	80° S–80° N	~1.6 km	10/1991–11/2005	NASA
POAM II	88° S–63° S, 55° N–71° N	~1 km	10/1993–11/1996	NRL
POAM III	88° S–62° S, 54° N–71° N	~1 km	04/1998–11/2005	NRL
SAGE I	79° S–79° N	~1 km	02/1979–11/1981	NASA ¹
SAGE II	80° S–80° N	~1 km	10/1984–08/2005	NASA

¹ L. W. Thomason, personal communication

Title Page

Abstract

Introduction

Conclusions

References

Tables

Figures

◀

▶

◀

▶

Back

Close

Full Screen / Esc

Printer-friendly Version

Interactive Discussion



A new database of trace gases and aerosols

B. Hassler et al.

Table 3. Altitude range of the satellite-based measurements incorporated in version 1.0 of the BDBP.

Variable	HALOE	POAM II	POAM III	SAGE I	SAGE II
O ₃	10–90 km	15–50 km	5–60 km	10–70 km	5–60 km
NO ₂	15–55 km	20–40 km	20–40 km	10–70 km	15–60 km
H ₂ O	10–80 km	–	5–45 km	–	10–40 km
Aerosols	15–50 km	10–30 km	5–25 km	10–40.5 km	1–45 km
HCl	15–60 km	–	–	–	–
HF	15–60 km	–	–	–	–
CH ₄	15–80 km	–	–	–	–
NO	10–130 km	–	–	–	–
Temperature	15–80 km	0–60 km	0–60 km	1–70 km	1–60 km

Title Page

Abstract

Introduction

Conclusions

References

Tables

Figures

◀

▶

◀

▶

Back

Close

Full Screen / Esc

Printer-friendly Version

Interactive Discussion



Appendix A

Ozonesonde stations contributing to the BDBP

Table A1. Sounding stations from which ozone profiles have been added. Note that for some stations only seasonal data are available although it is not specified in the table.

Station name	Latitude	Longitude	Time period	Data sources
Alert	82.49	-62.42	1987–2005	WOUDC
Eureka/Eureka Lab	80.04	-86.17	1992–2006	WOUDC
Ny Alesund	78.93	11.88	1990–2006	WOUDC
Thule	76.53	-68.74	1991–2005	WOUDC & NDACC
Resolute	74.72	-94.98	1966–2005	WOUDC
Summit	72.60	-38.50	2005–2006	NOAA
Barrow	71.31	-156.60	1974	WOUDC
Scoresbysund	70.50	-22.00	1989, 1991–2005	WOUDC & NDACC
Sodankyla	67.33	26.50	1988–2006	WOUDC & NDACC & pers. comm.
Salekhard	66.70	66.70	2005	NDACC
Poker Flat	65.13	-147.45	1979–1982	WOUDC
Fairbanks	64.81	-147.86	1965	WOUDC
Iqaluit	63.75	-68.55	1991–1992	WOUDC
Yakutsk	62.03	129.63	2004–2005	NDACC
Jokioinen	60.81	23.50	1995–1998	WOUDC
Lerwick	60.13	-1.18	1992–2001	WOUDC
Churchill	58.75	-94.07	1973–2006	WOUDC
Cold Lake	54.78	-110.05	1977–1981	WOUDC

ACPD

8, 7657–7702, 2008

**A new database of
trace gases and
aerosols**

B. Hassler et al.

Title Page

Abstract

Introduction

Conclusions

References

Tables

Figures

◀

▶

◀

▶

Back

Close

Full Screen / Esc

Printer-friendly Version

Interactive Discussion



Table A1. Continued.

Station name	Latitude	Longitude	Time period	Data sources
Edmonton	53.55	-114.10	1970, 1972–2005	WOUDC
Goose Bay	53.30	-60.36	1963, 1969–2006	WOUDC
Berlin/Tempelhof	52.46	13.43	1966–1973	WOUDC
Legionowo	52.40	20.96	1979–2006	WOUDC
Aberystwyth	52.40	-4.10	1991–2001	NDACC
Lindenberg	52.21	14.12	1975–2006	WOUDC
Vanscoy	52.11	-107.16	1992, 2000, 2002, 2004	WOUDC
Debilt	52.10	5.18	1992–2006	WOUDC & NDACC
Valentia Observ.	51.93	-10.25	1994–2004	WOUDC
Yorkton	51.26	-102.46	1975–1978	WOUDC
Uccle	50.80	4.35	1965–1967, 1969–2005	WOUDC & NDACC
Gimli	50.63	-97.05	1980, 1982–1983, 1985	WOUDC
Bratts Lake (Regina)	50.20	-104.70	2003–2006	WOUDC
Praha	50.02	14.45	1979–2006	WOUDC
Kelowna	49.92	-119.40	2003–2006	WOUDC
Hohenpeissenberg	47.80	11.02	1966–2006	pers. comm.
Spokane	47.66	-117.41	1976	WOUDC
Great Falls	47.48	-111.35	1977	WOUDC
Caribou	46.86	-68.03	1981	WOUDC
Thalwil	46.81	8.45	1966–1968	WOUDC
Payerne	46.49	6.57	1968, 1970–2006	WOUDC
Pellston	45.56	-84.68	2004	NOAA
S.Pietro Capofiume	44.65	11.61	1984, 1991–1993	WOUDC
Biscarrosse/SMS	44.36	-1.23	1976–1983	WOUDC
Egbert	44.23	-79.78	2003–2006	WOUDC
Haute Provence	43.93	5.70	1981, 1995–2006	WOUDC & NDACC

A new database of trace gases and aerosols

B. Hassler et al.

Title Page

Abstract

Introduction

Conclusions

References

Tables

Figures

◀

▶

◀

▶

Back

Close

Full Screen / Esc

Printer-friendly Version

Interactive Discussion



Table A1. Continued.

Station name	Latitude	Longitude	Time period	Data sources
Sable Island	43.93	−60.10	1997	NOAA
Yarmouth	43.87	−66.10	2003–2006	WOUDC
Toronto	43.78	−79.47	1976, 1978, 1980, 1982, 1987, 1994	WOUDC
Sapporo	43.06	141.33	1969–2006	WOUDC
Sofia	42.81	23.38	1982–1991	WOUDC
Ainsworth (Airport)	42.58	−100.00	1986	WOUDC
Bedford	42.45	−71.26	1969–1971	WOUDC
Rhode Island	41.40	−71.50	2004–2006	NOAA
Trinidad Head	40.80	−124.16	1999–2001	WOUDC
Purdue University	40.50	−87.00	1996	NOAA
Madrid/Barajas	40.46	−3.65	1994–2002, 2004–2006	WOUDC
Boulder	40.08	−105.25	1963–1966, 1979–1989, 1991–2006	WOUDC & NOAA & NDACC
Ankara	39.95	32.88	1994–2001	WOUDC
Denver	39.76	−104.88	1977	WOUDC
Cagliari	39.25	9.05	1968–1970, 1972–1980	WOUDC
Topeka	39.06	−95.63	1963	WOUDC
Sterling	38.98	−77.48	1962–1966	WOUDC
Virginia	38.10	−78.50	1996	NOAA
Wallops Island	37.89	−75.48	1970–1982, 1984–2006	WOUDC & NDACC
El Arenosillo	37.10	−6.73	1983	WOUDC
Nashville	36.25	−86.65	1995, 1999	NOAA
Tateno	36.06	140.10	1968–2006	WOUDC
Huntsville	35.28	−86.58	1999–2003	WOUDC
Cheju	33.50	126.50	2001	WOUDC

A new database of trace gases and aerosols

B. Hassler et al.

Title Page

Abstract

Introduction

Conclusions

References

Tables

Figures

◀

▶

◀

▶

Back

Close

Full Screen / Esc

Printer-friendly Version

Interactive Discussion



Table A1. Continued.

Station name	Latitude	Longitude	Time period	Data sources
Long View	32.50	−94.75	1976	WOUDC
Isfahan	32.47	51.42	1995–1996, 1999–2005	WOUDC
San Diego	32.45	−117.11	1977	WOUDC
Palestine	31.80	−95.71	1975–1985	WOUDC
Kagoshima	31.58	130.56	1969–2005	WOUDC
McDonald Observ.	30.66	−90.93	1969	WOUDC
Houston	29.94	−95.54	2000	NOAA
New Delhi	28.65	77.21	1969, 1971–1976, 1983–1986, 1994–2003	WOUDC
Izana	28.48	−16.26	1995–2006	WOUDC & NDACC
Naha	26.20	127.68	1989–2006	WOUDC
Taipei	25.02	121.47	2000–2001	WOUDC
Mount Abu	24.60	72.70	1965–1966	WOUDC
Hong Kong Observ.	22.31	114.17	2000–2006	WOUDC
Bombay	19.11	72.85	1968–1969	WOUDC
Poona	18.53	73.85	1966, 1968–1976, 1982–1986, 1994–2000, 2002–2003	WOUDC
San Juan	18.48	−66.13	1976	WOUDC
Coolidge Field	17.28	−61.78	1976	WOUDC
Hilo	19.70	−155.06	1964–1965, 1982–1997, 1999–2006	WOUDC & NDACC
Heredia	10.00	−84.11	2005–2006	WOUDC & SHADOZ
Ft. Sherman	9.33	79.98	1977	WOUDC
Albrook	8.98	−79.55	1980	WOUDC
Thivandrum	8.48	76.95	1969, 1973–1976, 1983–1986, 1994–2000, 2002–2003	WOUDC
Paramaribo	5.81	−55.21	1999–2006	WOUDC & NDACC

A new database of trace gases and aerosols

B. Hassler et al.

Title Page

Abstract

Introduction

Conclusions

References

Tables

Figures

◀

▶

◀

▶

Back

Close

Full Screen / Esc

Printer-friendly Version

Interactive Discussion



Table A1. Continued.

Station name	Latitude	Longitude	Time period	Data sources
Kourou	5.33	−52.65	1974	WOUDC
Kaashidhoo	5.00	73.50	1999	WOUDC & NOAA
Sepang Airport	2.73	101.70	1998–2006	WOUDC
Christmas Island	2.01	−157.40	1999	SHADOZ
San Cristobal	−0.92	−89.60	1998–2006	WOUDC & SHADOZ
Nairobi	−1.26	36.80	1996–2006	WOUDC & SHADOZ
Canton Island	−2.76	−171.70	1965	WOUDC
Malindi	−2.99	40.19	1999–2006	WOUDC & SHADOZ
Brazzaville	−4.28	15.25	1990–1992	WOUDC
Maxaranguape	−5.44	−35.33	2002–2006	WOUDC
Natal	−5.84	−35.21	1979–1982, 1990–1992, 1997–2006	WOUDC & NDACC
Watukosek (Java)	−7.57	112.65	1998–2006	WOUDC
Ascension Island	−7.98	−14.42	1990–1992, 1997–2003, 2005	WOUDC
Porto Nacional	−10.80	−48.40	1992	WOUDC
Chilca	−12.50	−76.80	1975	WOUDC
Samoa	−14.25	−170.56	1995–2006	WOUDC
Lusaka	−15.42	28.32	2000	SHADOZ
Cuiaba	−15.60	−56.10	1992	WOUDC
Ovejuyo	−16.51	−68.03	1965	WOUDC
Papeete (Tahiti)	−18.00	−149.00	1995–1999	WOUDC & NOAA
Suva (Fiji)	−18.13	178.31	1997–2005	WOUDC & SHADOZ
Etosha Pan	−19.20	15.90	1992	WOUDC
La Reunion Island	−21.07	55.48	1998–2006	WOUDC & SHADOZ
Irene	−25.91	28.21	1990–1993, 1998–2006	WOUDC

A new database of trace gases and aerosols

B. Hassler et al.

Title Page

Abstract

Introduction

Conclusions

References

Tables

Figures

⏪

⏩

◀

▶

Back

Close

Full Screen / Esc

Printer-friendly Version

Interactive Discussion



Table A1. Continued.

Station name	Latitude	Longitude	Time period	Data sources
Easter Island	−27.17	−109.42	1995–1997	WOUDC
Broadmeadows	−37.69	144.94	1999–2003	WOUDC
Laverton	−37.86	144.75	1982–1999	WOUDC
Aspendale	−38.03	145.10	1965–1982	WOUDC
Puerto Montt	−41.45	−72.83	1964–1965	WOUDC
Christchurch	−43.48	172.55	1965	WOUDC
Lauder	−45.038	169.684	1986–2006	Lauder archive
Macquarie Island	−54.50	158.96	1994, 1996–2003	WOUDC
Marambio	−64.23	−56.71	1988–1998, 2006	WOUDC
Wilkes	−66.25	110.51	1963	WOUDC
Dumont d'Urville	−66.41	140.01	1991–2006	NDACC
Davis	−68.57	77.97	2003–2005	WOUDC
Syowa	−69.00	39.58	1966–1975, 1977–1984, 1986–2006	WOUDC
Maitri	−70.46	11.45	1994–1998	WOUDC
Neumayer	−70.65	−8.25	1992–2006	WOUDC
Hallett	−72.31	170.21	1962–1963	WOUDC
McMurdo	−77.85	166.67	1986–2005	NDACC
Byrd	−80.03	−119.51	1963–1966	WOUDC
Amundsen-Scott	−89.98	−24.80	1962, 1964–1971, 1986–1987, 1991–2006	WOUDC & NDACC
Ship 1	–	–	1965–1966	WOUDC
Ship 3	–	–	1999	WOUDC

A new database of trace gases and aerosols

B. Hassler et al.

Title Page

Abstract

Introduction

Conclusions

References

Tables

Figures

◀

▶

◀

▶

Back

Close

Full Screen / Esc

Printer-friendly Version

Interactive Discussion



A new database of trace gases and aerosols

B. Hassler et al.

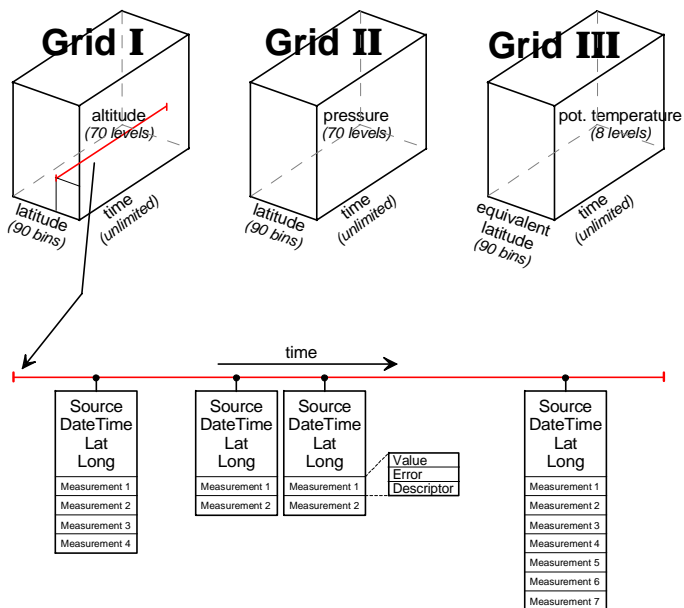

Fig. 1. Schematic overview of the database structure. For all three database grids there are 90 latitude bins. The number of altitude levels changes for the different database grids: Grid I and II have 70 levels while Grid III has 8 levels.

Title Page

Abstract

Introduction

Conclusions

References

Tables

Figures

◀

▶

◀

▶

Back

Close

Full Screen / Esc

Printer-friendly Version

Interactive Discussion



A new database of trace gases and aerosols

B. Hassler et al.

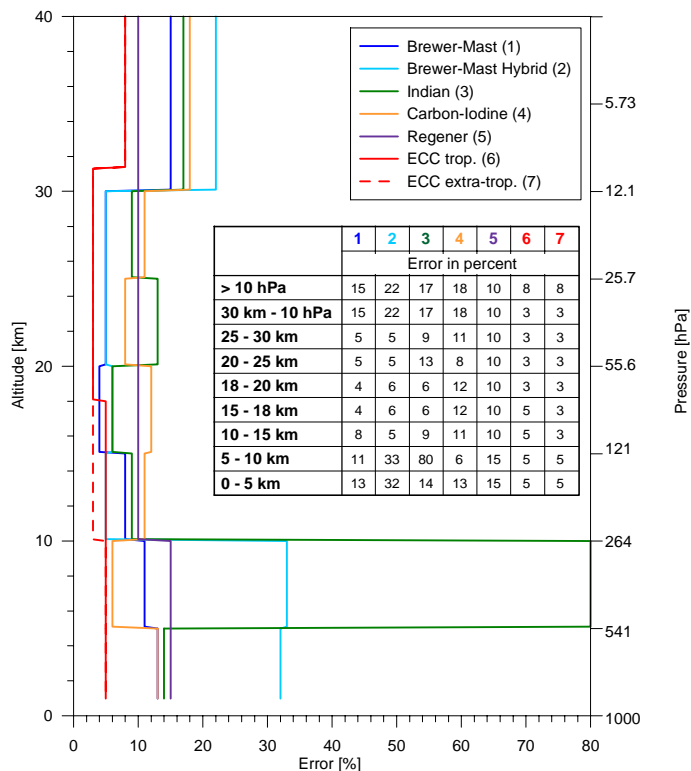

Fig. 2. Ozone errors [%] for 6 different ozonesonde types and different altitude/pressure regions as included in the BDBP. Values are obtained from [Smit and Kley \(1996\)](#), or [Komhyr et al. \(1985\)](#).

Title Page

Abstract

Introduction

Conclusions

References

Tables

Figures

◀

▶

◀

▶

Back

Close

Full Screen / Esc

Printer-friendly Version

Interactive Discussion



**A new database of
trace gases and
aerosols**B. Hassler et al.

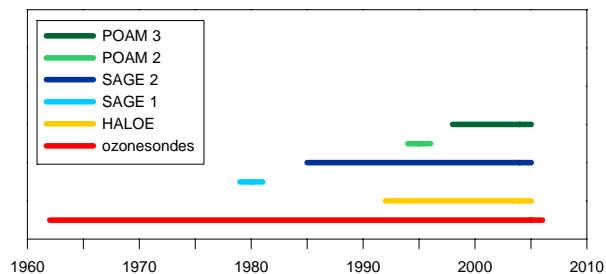

Fig. 3. Temporal coverage of the database. The red line represents the time period which is covered by ozonesonde data, the yellow line represents the coverage by HALOE etc.

[Title Page](#)[Abstract](#)[Introduction](#)[Conclusions](#)[References](#)[Tables](#)[Figures](#)[◀](#)[▶](#)[◀](#)[▶](#)[Back](#)[Close](#)[Full Screen / Esc](#)[Printer-friendly Version](#)[Interactive Discussion](#)

**A new database of
trace gases and
aerosols**

B. Hassler et al.

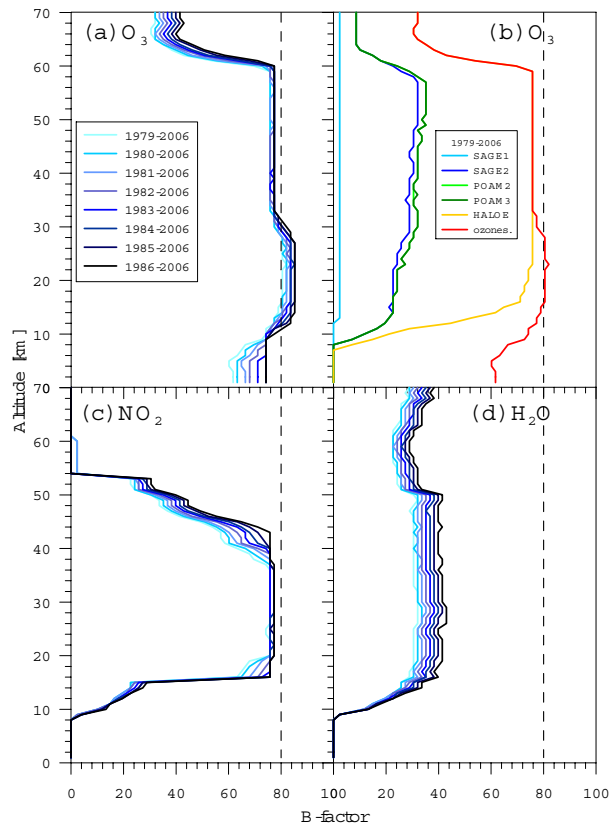

Fig. 4. B-factors for O₃, NO₂ and H₂O as a function of changing time period (panels **(a)**, **(c)** and **(d)** respectively) and for O₃ as a function of changing data source (panel **(b)**). The 80% level in all panels is shown for reference.

Title Page

Abstract

Introduction

Conclusions

References

Tables

Figures

◀

▶

◀

▶

Back

Close

Full Screen / Esc

Printer-friendly Version

Interactive Discussion



**A new database of
trace gases and
aerosols**

B. Hassler et al.

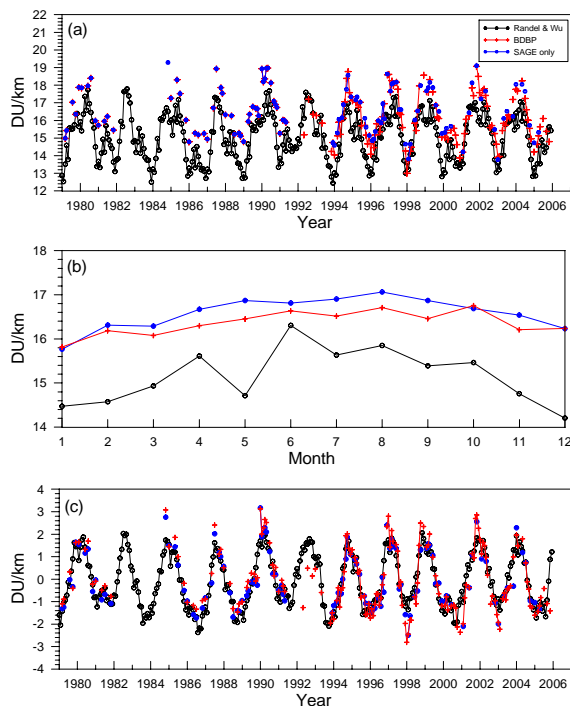

Fig. 5. (a) Monthly mean ozone number density (in DU/km) at the equator and 25 km from the BDBP (red crosses with lines joining adjacent values) and from R&W (black open circles with lines joining adjacent values). To investigate the effects of adding data to the BDBP in addition to SAGE I and SAGE II, monthly means calculated from SAGE I and SAGE II only are also shown (blue dots with lines joining adjacent values). (b) A comparison of the mean annual cycles calculated from the monthly means plotted in panel (a) where R&W values were excluded when BDBP values were not available to avoid any temporal biasing. (c) The monthly mean ozone anomaly times series calculated by subtracting the mean annual cycles plotted in panel (b) from the time series plotted in panel (a).

[Title Page](#)[Abstract](#)[Introduction](#)[Conclusions](#)[References](#)[Tables](#)[Figures](#)[◀](#)[▶](#)[◀](#)[▶](#)[Back](#)[Close](#)[Full Screen / Esc](#)[Printer-friendly Version](#)[Interactive Discussion](#)

**A new database of
trace gases and
aerosols**

B. Hassler et al.

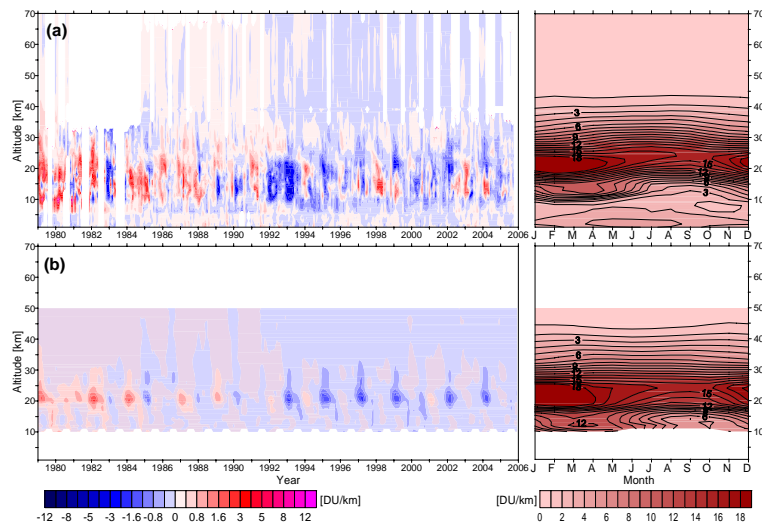

Fig. 6. (a) Ozone anomalies (left) and mean annual cycle (right) for data extracted from the BDBP, for altitudes between 1 km and 70 km and for the latitude zone from 40° N to 50° N. (b) same as a), for data extracted from R&W. White areas indicate where no values are available.

[Title Page](#)[Abstract](#)[Introduction](#)[Conclusions](#)[References](#)[Tables](#)[Figures](#)[◀](#)[▶](#)[◀](#)[▶](#)[Back](#)[Close](#)[Full Screen / Esc](#)[Printer-friendly Version](#)[Interactive Discussion](#)

**A new database of
trace gases and
aerosols**

B. Hassler et al.

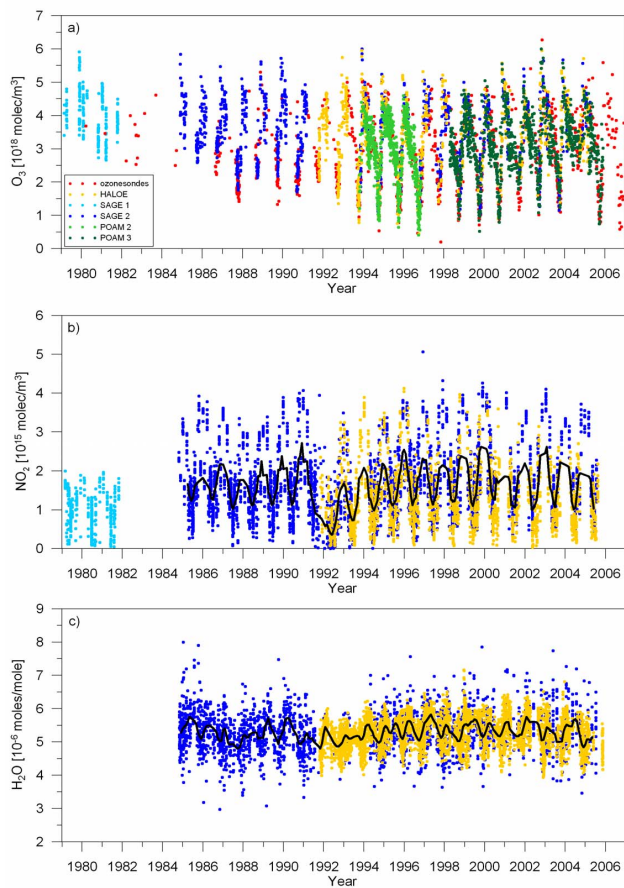

Fig. 7.

[Title Page](#)[Abstract](#)[Introduction](#)[Conclusions](#)[References](#)[Tables](#)[Figures](#)[◀](#)[▶](#)[◀](#)[▶](#)[Back](#)[Close](#)[Full Screen / Esc](#)[Printer-friendly Version](#)[Interactive Discussion](#)

**A new database of
trace gases and
aerosols**B. Hassler et al.

Fig. 7. Individual data values extracted from the database for three different species. The different data sources are colour coded. **(a)** Ozone (in 10^{18} molec/m³) at the 550 K isentropic level for equivalent latitudes south of 70° S extracted from Grid III. For clarity only every 5th data point of SAGE II, HALOE, POAM II and POAM III is plotted. **(b)** NO₂ (in 10^{15} molec/m³) at 25 km altitude between 44° S and 46° S extracted from Grid I. The thick black line represents the 3-month running mean for the monthly means calculated from all data points. **(c)** H₂O (in 10^{-6} moles/mole) between 9 hPa and 7 hPa for the latitude band 30–40° N extracted from Grid II. For clarity only every 5th data point from SAGE II and HALOE is plotted. The thick black line represents the 3-month running mean for the monthly means calculated from all data points.

[Title Page](#)[Abstract](#)[Introduction](#)[Conclusions](#)[References](#)[Tables](#)[Figures](#)[I◀](#)[▶I](#)[◀](#)[▶](#)[Back](#)[Close](#)[Full Screen / Esc](#)[Printer-friendly Version](#)[Interactive Discussion](#)